

Owner Instructions

Original Instructions

Warning! Read instructions before using the machine



www.numatic.com

Operating Instructions

WV 570

WVD 570

WV 750

WV 750T

WVD 750

WVD 750T

WV 900

WVD 900

WVD 1800-DH

WVD 1800-PH

WVD 1800-AP



**WVD
1800DH**



WVD 1800DH WVD 1800PH WVD 1800AP



BS7



WV 570 WV 900
WVD 570 WVD 900



BS8

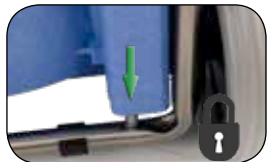
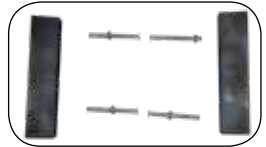

WV 900 / WVD 900



*WVD 1800PH
WVD 1800AP*



*WD 570
WVD 570
WV 900
WVD 900
WVD 1800DH*



*WVD 1800PH
WVD 1800AP*





WV 570 / WVD 570

WV 570 / WVD 570



WV 900 / WVD 900

WV 900 / WVD 900



WV 750T / WVD 750T

WV 750T / WVD 750T

Wet - Emptying the machine



Wet - Emptying the machine.



WVD 1800DH



WVD 1800DH



WVD 1800PH





WVD 1800 AP



WVD 1800 AP

Wet - Emptying the machine

WVD 1800DH / WVD 1800PH / WVD 1800AP



Cleaning the filter

WV 570
WVD 570
WV 900
WVD 900



WV 570 / WVD 570
NVM - 3BH



WV 900 / WVD 900
NVM - 4BH



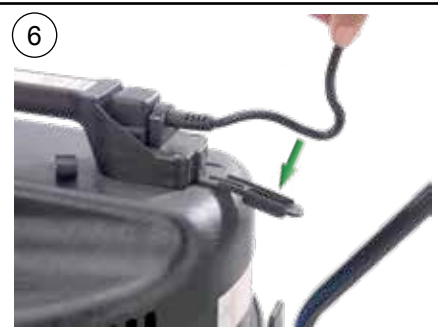

Data

WV / WVD 570

	Motor	AirFlo	Suction	Cleaning Range	Class
WV570 WVD 570	1060 W 1060 W x 2	49 L/sec 98 L/sec	2400 mm w.g. 2400 mm w.g.	26.8m 26.8m	II
	Capacity Dry	Capacity Wet	Size	Weight	Sound Pressure
WV 570 WVD 570	23 Ltrs 23 Ltrs	15 Ltrs 15 Ltrs	415 x 415 x 645 mm	16.3 Kgs 18.5 Kgs	73.6-79 dB (IEC 60704-2-1) Uncertainty: 0.2 dB (A)

WV / WVD 750 (T)

	Motor	AirFlo	Suction	Cleaning Range	Class
WV750 WVD 750 WVD 750 T	1060 W 1060 W x 2 1060 W x 2	49 L/sec 98 L/sec 98 L/sec	2400 mm w.g. 2400 mm w.g. 2400 mm w.g.	26.8m 26.8m 26.8m	II II II
	Capacity Dry	Capacity Wet	Size	Weight	Sound Pressure
WV750 WVD 750 WVD 750 T	35 Ltrs 35 Ltrs 35 Ltrs	25 Ltrs 25 Ltrs 25 Ltrs	680 x 550 x 940 mm	21.4 Kgs	77.5-76.9 dB (IEC 60704-2-1) Uncertainty: 0.2 dB (A)

WV / WVD 900





	Motor	AirFlo	Suction	Cleaning Range	Class
WV900 WVD 900	1060 W 1060 W x 2	49 L/sec 98 L/sec	2400 mm w.g. 2400 mm w.g.	26.8m 26.8m	II II
	Capacity Dry	Capacity Wet	Size	Weight	Sound Pressure
WV 900 WVD 900	40 Ltrs 40 Ltrs	32 Ltrs 32 Ltrs	490 x 800 x 880 mm	25.2 Kgs 28 Kgs	73.6-79 dB (IEC 60704-2-1) Uncertainty: 0.2 dB (A)

WV / WVD 1800 DH / PH / AP

	Motor	AirFlo	Suction	Cleaning Range	Class
WV 1800DH WVD 1800DH WV 1800PH WVD 1800PH WV 1800AP WVD 1800AP	1060 W 1060 W x 2 1060 W 1060 W x 2 1060 W 1060 W x 2	49 L/sec 98 L/sec 49 L/sec 98 L/sec 49 L/sec 98 L/sec	2400 mm w.g. 2400 mm w.g. 2400 mm w.g. 2400 mm w.g. 2400 mm w.g. 2400 mm w.g.	26.8m 26.8m 26.8m 26.8m 26.8m 26.8m	II II I I I I
	PH / AP Pump Motor	Capacity Wet	Size	Weight	Sound Pressure
WV / WVD 1800DH WV / WVD 1800PH WV / WVD 1800AP	---- 50W 500W	70 Ltrs 70 Ltrs 70 Ltrs	684 x 785 x 935 mm	31.5 / 34 Kgs 40.4 Kgs 40.4 Kgs	73-77 dB (IEC 60704-2-1) Uncertainty: 0.2 dB (A)

About the machine









Company name and address

Numatic International Ltd CHARD, ENGLAND TA20 2GB	
WV 900	Machine Description
220V - 240V	
50Hz - 60Hz	Voltage / Frequency
1200W MAX	Power Rating
1000 IEC	
22.5Kg	Weight (Ready to use)
IPX4	Splash Proof Rating
	Class 2 Symbol
	WEEE Logo
	CE Mark
 094400019	Yr / Wk / Serial Number

Safety Critical Components	
Mains lead	HO5VV-F x 10m x 2 x 1.00mm ² HO5VV-F x 10m x 3 x 1.50mm ²
Filter Bag	NVM-3 BH >pp< construction 99.6%@0.3µm NVM-4 BH >pp< construction 99.6%@0.3µm
Filter	Permatex NVM 604116 >pp< construction 96.0%@0.3µm

WEEE Legislation (Waste, Electrical and Electronic Equipment)
Vacuum cleaner, accessories and packaging should be sorted for environmental-friendly recycling.
Only for EU countries: Do not dispose of Vacuum cleaner into household waste!
According to the European Directive 2002/96/EC on waste electrical and electronic equipment and its incorporation into national law.
Vacuum cleaners that are no longer suitable for use must be separately collected and sent for recovery in an environmental-friendly manner.



PPE	
Personal protective equipment that may be required for certain operations.	
	
Ear Protection	Safety Footwear
	
Head Protection	Safety Gloves
	
Dust / Allergens Protection	Eye Protection
	
	
Hi Viz Jacket	Caution Floorsign
NOTE: A risk assessment should be conducted to determine which PPE should be worn.	

Information for Wet & Dry Use Vacuum Cleaners

WARNING

Read the instruction manual before using the machine.

Operators shall be adequately instructed on the use of these machines.

As with all electrical equipment, care and attention must be exercised at all times during use, in addition to ensuring that routine and preventative maintenance is carried out periodically to ensure safe operation.

Failure to carry out maintenance as necessary, including the replacement of parts to the correct standard could render this equipment unsafe and the manufacturer can accept no responsibility in this respect.

The machine shall be disconnected from the mains by removing the plug from the supply socket during cleaning or maintenance and when replacing parts or converting the machine to another function.

The machine is not to be used by children or persons with reduced physical, sensory or mental capabilities, or lack of experience or knowledge, unless they have been given supervision or instruction.

Children being supervised are NOT to play with the machine.

This appliance is intended to be assembled, cleaned and maintained by an adult.

This machine is not a toy.

Only use the socket outlet on the machine for purposes specified in the instructions.

CAUTION!

If foam/liquid comes out of machine exhaust, switch off immediately. Allow the accumulated liquid to drain out through the machine exhaust, check the float assembly to ensure correct operation, empty the container if full of liquid, reassemble the machine. Immediately upon start up there will be a certain amount of liquid issuing from the machine exhaust which will be the residue of liquid still within the power head. This will be quickly discharged after which the machine should function normally.

Liquid ejected from the machine could be hazardous as a result of its temperature, pressure or chemical content.

This machine is not suitable for the collection of biological hazards, hazardous or explosive dust. You should contact your local distributor if you require a machine capable of performing these tasks.

Ensure that the filtration system fitted to the machine is suitable for the material being collected.

This machine is for indoor use only.

This machine shall be stored indoors only

This product complies with the requirements IEC 60335 -2.69.

When moving from one place to another, consider the weight of the machine.

NOTE: This machine is also suitable for commercial use, for example in hotels, schools, hospitals, factories, shops and offices for other than normal housekeeping purposes.

DO

- Use a bag and filter at all times when using 'dry'.
- Keep your machine clean.
- Keep filters clean.
- Regularly clean the water level limiting float safety valve and examine for signs of damage or correct operation.
- Keep hoses and tubes clear.
- Replace any worn or damaged parts immediately.
- Regularly examine the power cord, if damage is found, power cord must be replaced by a qualified person using the correct Numatic original part.
- Empty dust container frequently.
- Keep diffuser filter (where fitted) clean.

DON'T

- Use steam cleaners or pressure washers to clean the machine or use the machine in the rain.
- Immerse in water for cleaning.
- Allow any inexperienced repairs. Call the experts.
- Use wet if float valve is not functioning or fitted.
- Use to suck up hot ashes, or lighted cigarette ends.
- Suck up liquid before emptying dirt from container.
- Suck up dirt before emptying liquid from container.
- Run the machine over the power cable during operation as a hazard may occur.
- Pull on the cable to unplug the machine from the power supply.
- Walk over-wet carpets, upholstery or fabrics.
- Walk on clean carpets until fully dry.
- Spray onto people or animals.
- Attempt machine maintenance or cleaning unless the power supply plug has been removed from the supply outlet.

This machine can be used for wet and dry pick up.

Dry Mode maintenance / fault finding

If the vacuum cleaner stops working switch off and remove the plug from the wall before investigating were the fault lies.

If the vacuum cleaner will not pick up any debris from the surface, switch off and remove the plug from the wall, inspect the floor tool, wands and hose for blockages, if no blockages are found, the dust bag may be full if the dust bag is not full the filter may be blocked.

Wet mode / fault finding

If the vacuum cleaner stops working switch off and remove the plug from the wall before investigating were the fault lies.

If the vacuum cleaner has a blockage and will not pick up liquid, switch off and remove the plug from the wall, has the float valve operated, this will shut off the suction and the pitch of the vacuum motor will change Remove the power head and empty the liquid out of the container, if the container is empty, check that the floor tool wands and hose are not blocked.

After use always inspect the machine for damage.

	Failure to rectify the problem or in the event of a breakdown contact your Numatic dealer or the Numatic Technical Helpline +44 (0)1450 269268
	Wenn Sie das Problem nicht beheben können oder wenn es zu einer Störung kommt, wenden Sie sich an Ihren Numatic-Händler oder rufen Sie bei der Numatic Technical Helpline an unter 0049 (0)511 9842160.
	Si vous ne parvenez pas résoudre le problème ou en cas de panne, contactez votre revendeur Numatic ou le service d'assistance technique Numatic au +331164726161
	Neem contact op met uw Numatic-verdeler als u het probleem niet kunt verhelpen of de machine dienst weigert. U kunt ook de technische hulplijn van Numatic bellen op +31 172 467 999
	Failure to rectify the problem or in the event of a breakdown contact your Numatic dealer or the Numatic Technical Helpline 0861 696 284



16

**EU DECLARATION
OF
CONFORMITY**

We hereby declare under our sole responsibility that the following equipment fulfils all the relevant provisions of the following EU Directives:

Machinery Directive 2006/42/EC
EMC Directive 2014/30/EU
RoHS Directive 2011/65/EU

Machine Description: **Vacuum Cleaner**
Type: **WVD, WV, CV, CVD series**

Manufactured by: Numatic International Limited

Relevant standards upon which conformity is declared include:

IEC 60335-1 2001 + A1 2004 + A2 2006 + National Deviations
IEC 60335-2-2 2002 + A1 +A2
IEC 60335-2.69 2002 + A2

EN 55014-1 2001 +A1 2001, +A2 2002
EN 55014-2 1997 + A1 2001 (Cat II)
EN 50366 2003 + A1 2006

A technical construction file for this equipment is retained at the manufacturer's address under the authorisation of the following signatory:

Name: Allyn Boyes **Position:** Technical Manager

Signed:  Date: 20/04/2016



Numatic International Limited,
Chard, Somerset.
TA20 2GB
www.numatic.co.uk

GB

14" Simplex AP/PH 240V / 120V WD-0244 (A03)

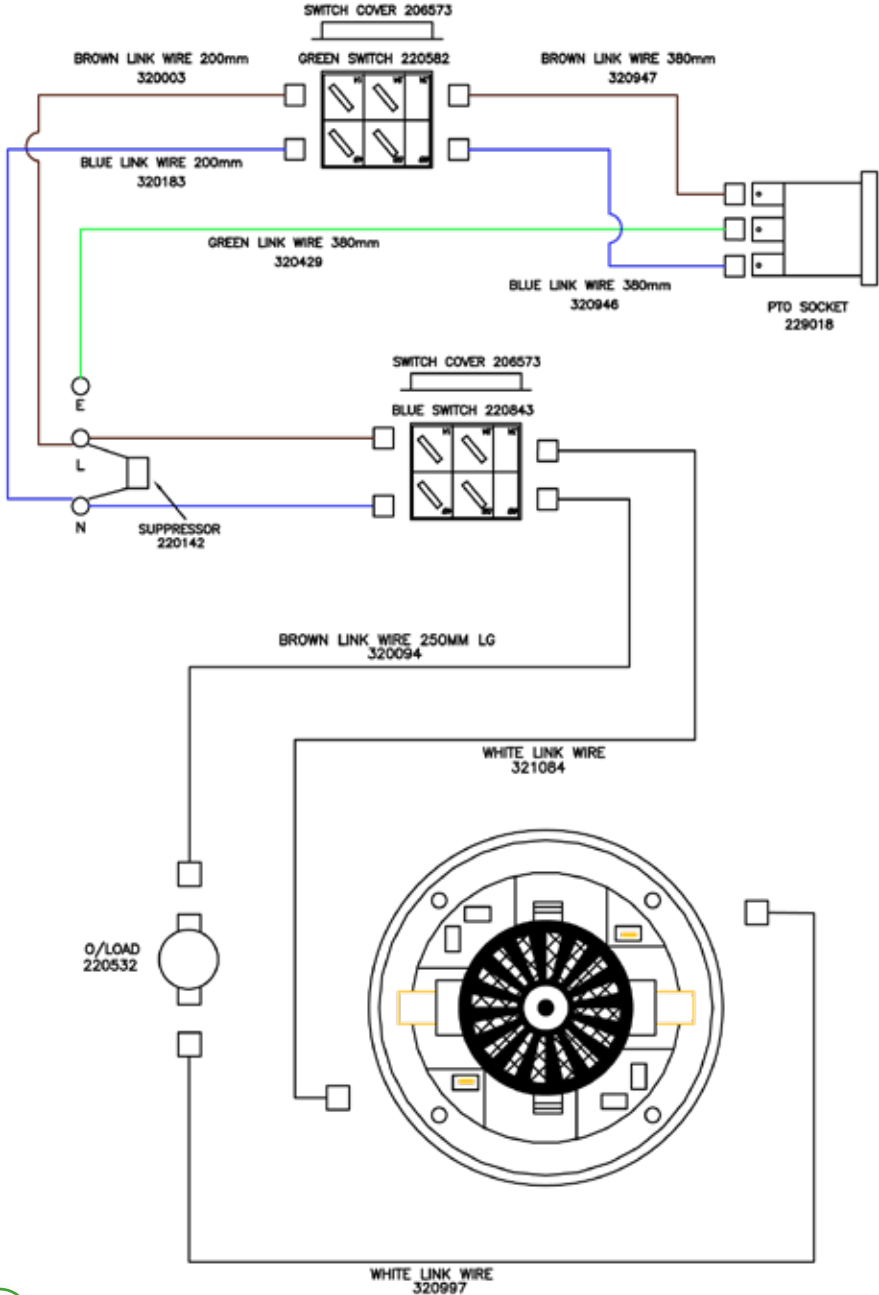

14" Duplex PTO 240V WD-0246 (A06)

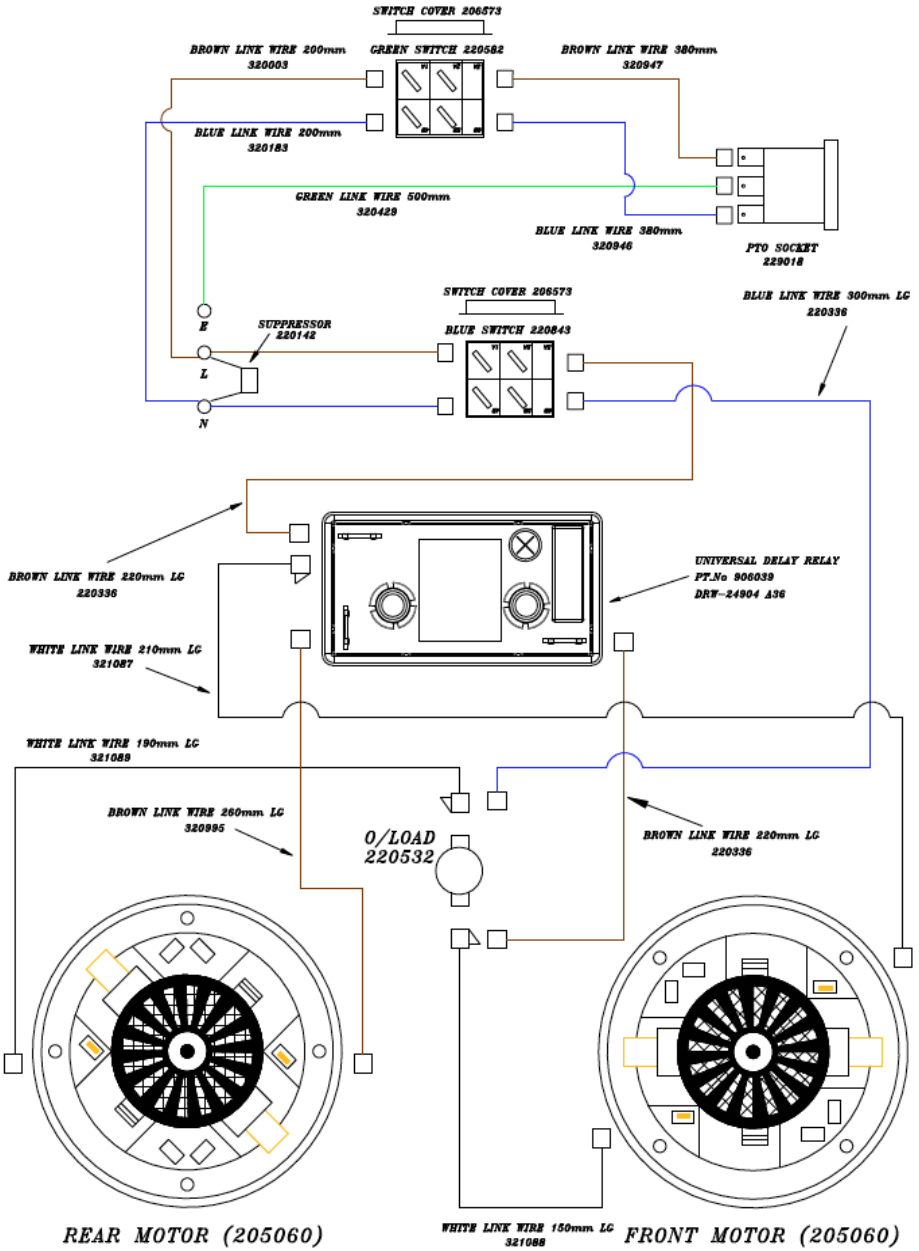

14" WVD Duplex 230V
WD-0255 (A06)

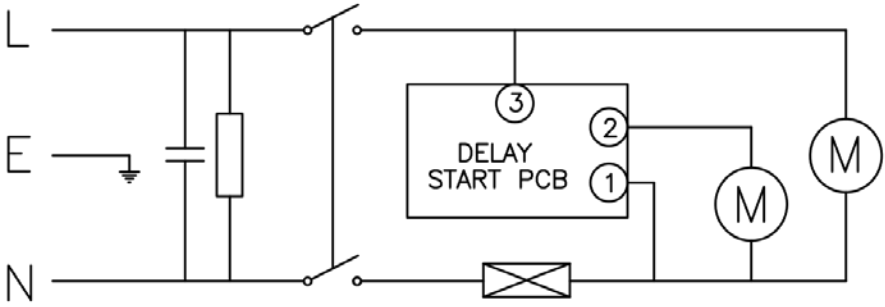

14" WV Simplex 240V / 120V
WD-0245 (A05)

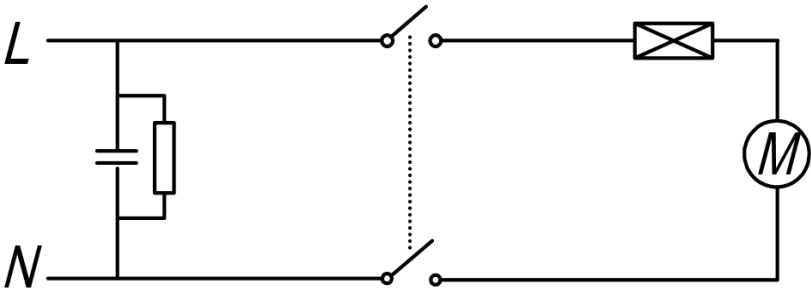

14" WV Simplex AP/PH 220V
17/03/05 WD-0288 (A01)

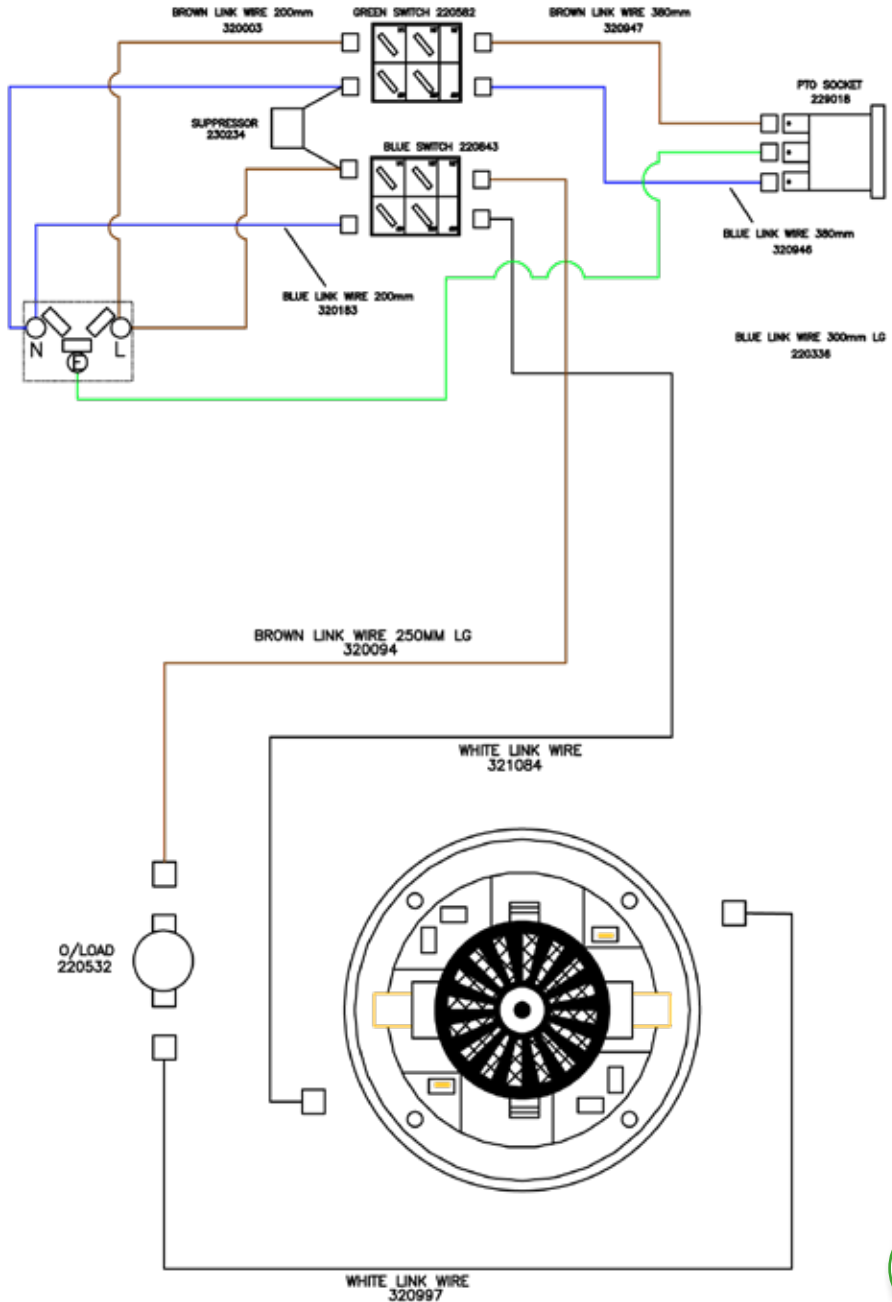

14" WV Simplex 220V
WD-0289 (A01)

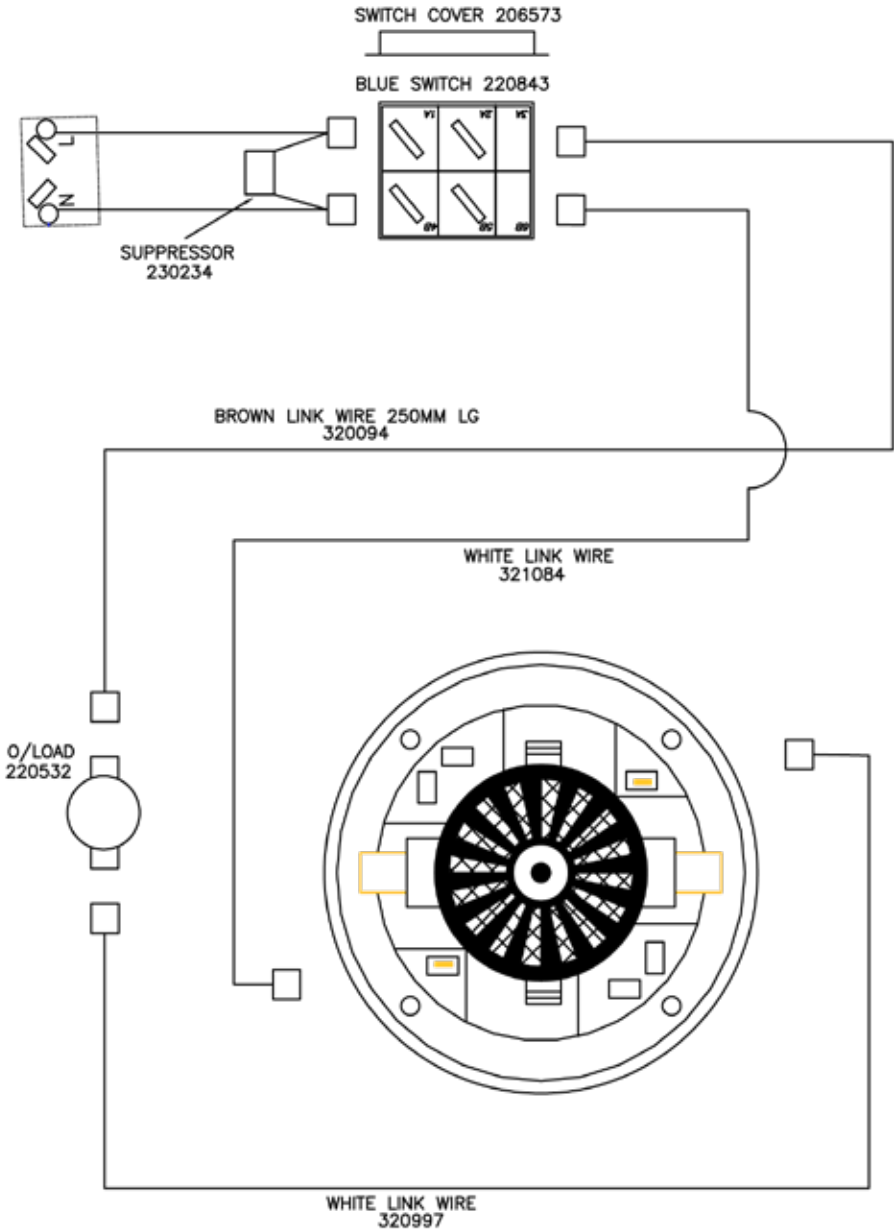

14" WV Duplex AP/PH 220V WD-0290 (A03)

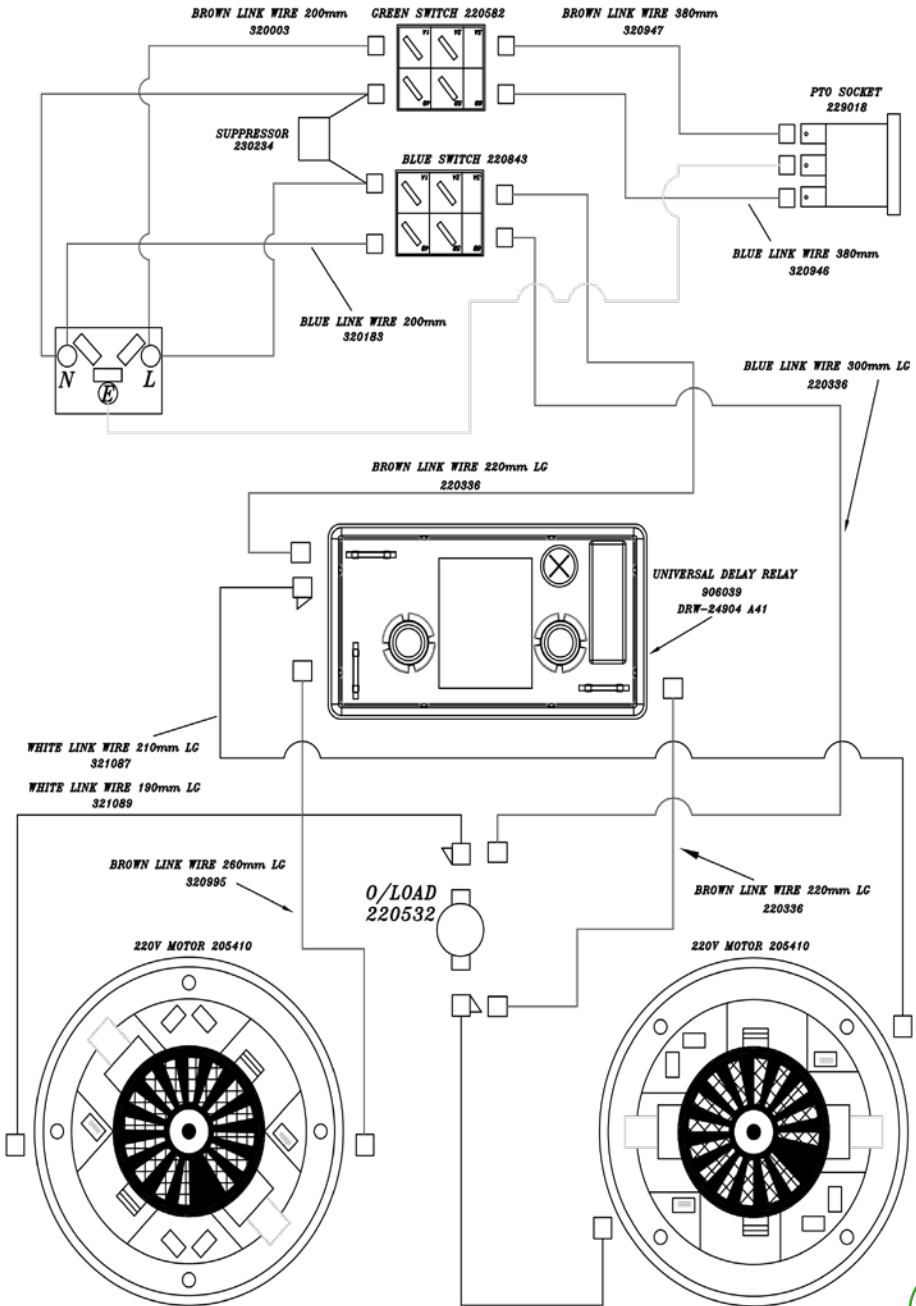

14" WV Duplex 220V WD-0293 (A03)

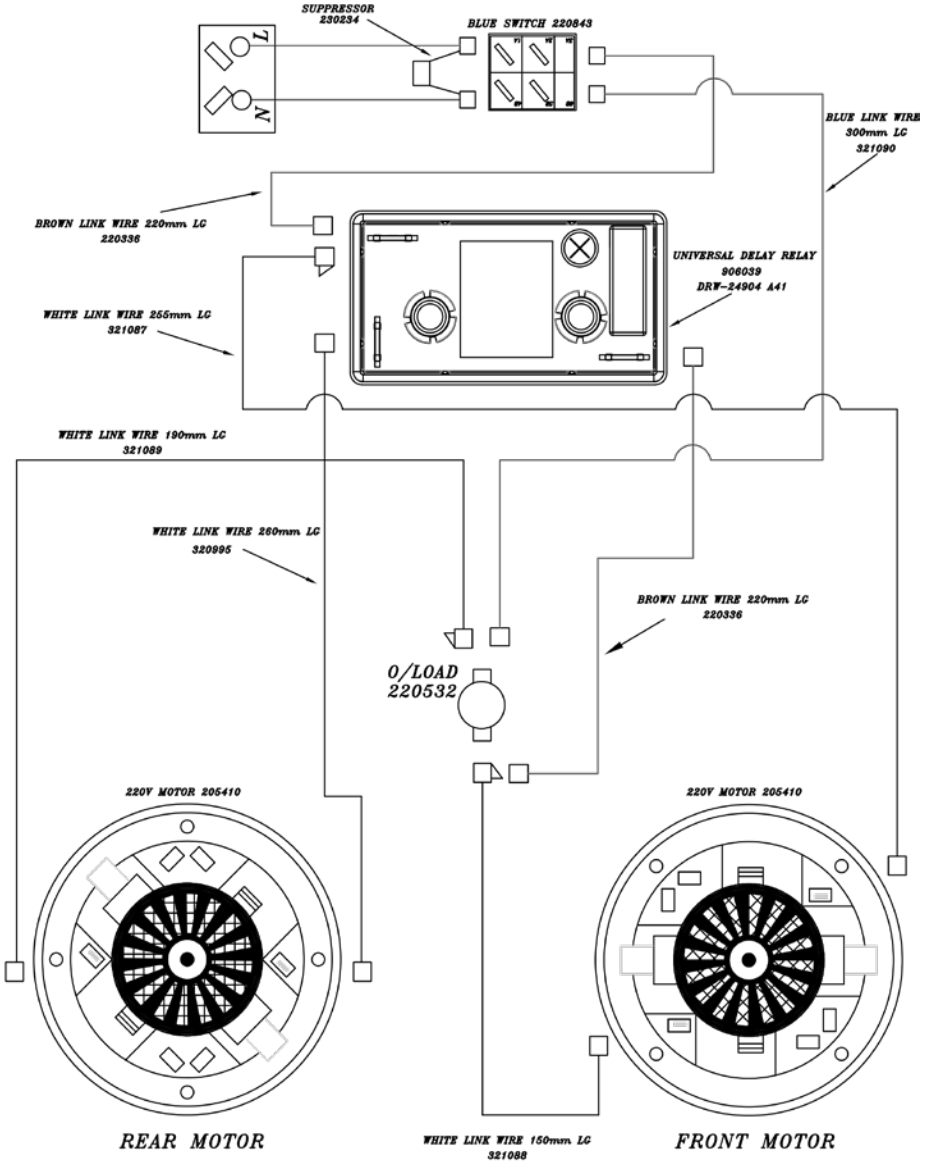

14" WV Duplex PTO120V WD-0259 (A03)

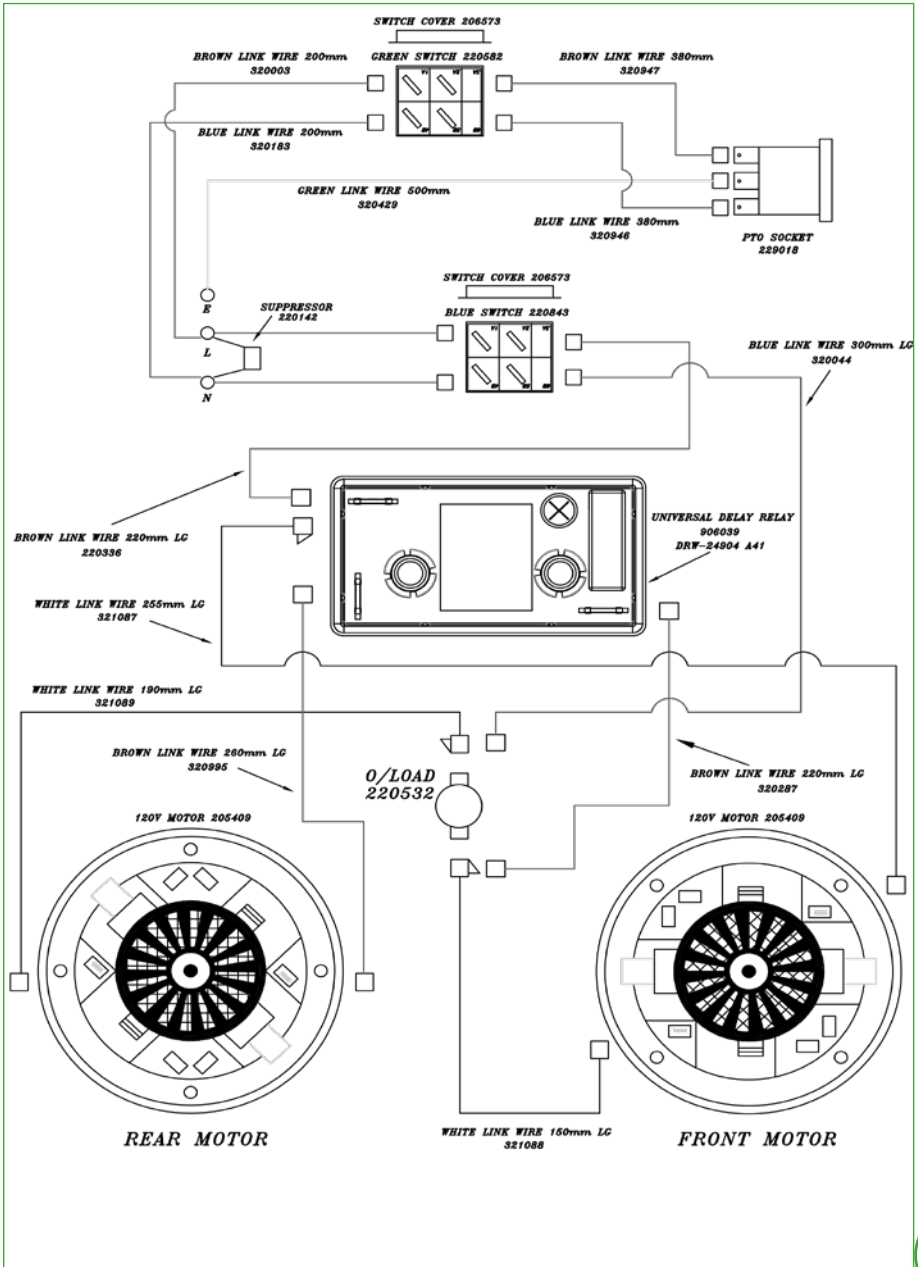

14" WV Duplex 120V
WD-0257 (A03)

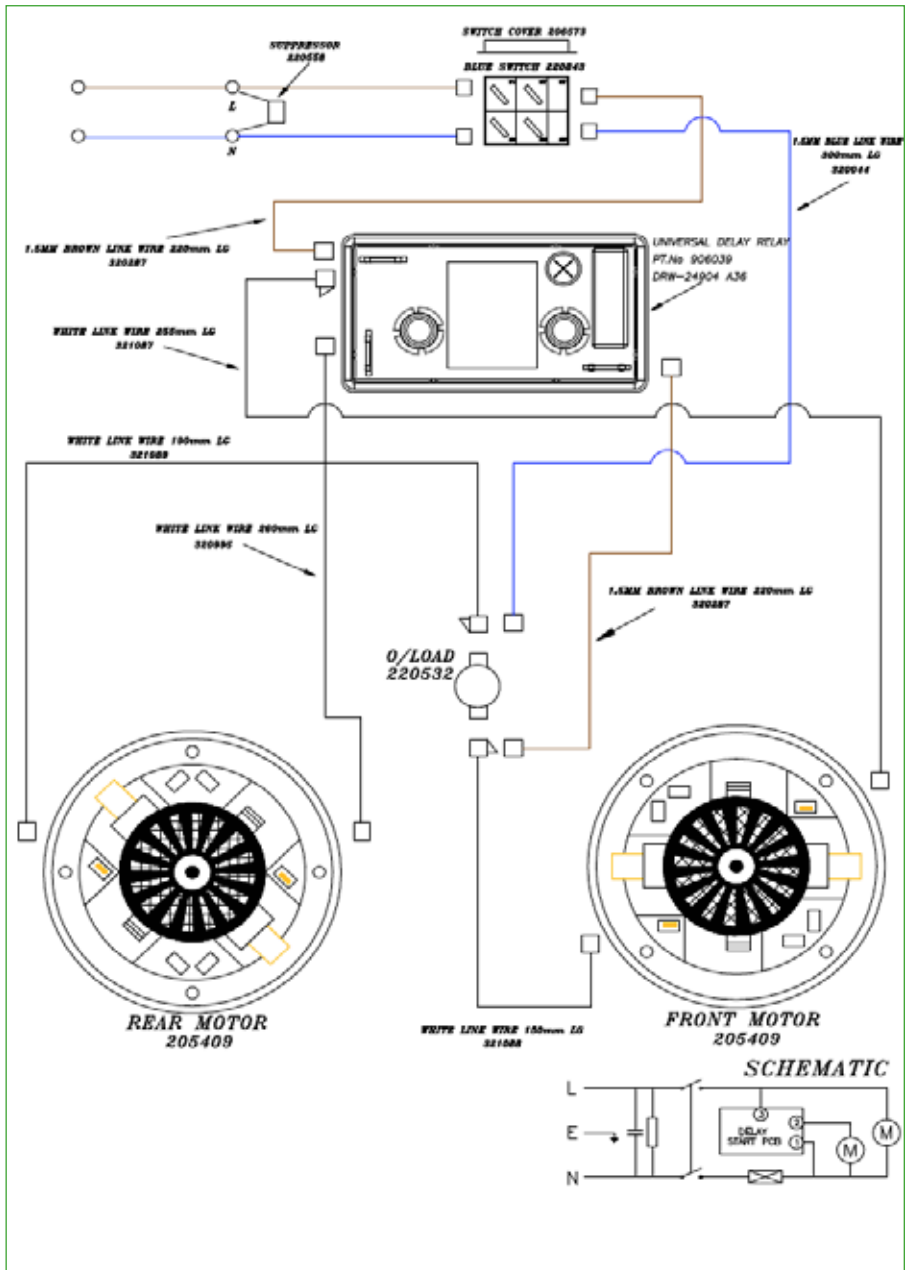

Numatic International Warranty

Numatic International Limited warrant to the original purchaser that its products are free of defects in both material or workmanship for the period shown below:-

Homecare and Cleancare Vacuum cleaners.....	2 Years
Rotary Floor Machines.....	2 Years
Twintec Auto Scrubber Dryer.....	1 Year
Vario Ride-On Scrubber Dryer.....	1 Year / 1500 hours
Mopping, Compacts, Combi and Servocare Products.....	1 Year
Individual Accessories and Spare Parts.....	6 Months

Note: This warranty expressly excludes consumable parts such as carbon brushes, floor brushes, mops, batteries etc, that are considered replaceable from time to time during the normal working life of the machine.

Using non Numatic dustbags can be detrimental to both machine performance and life and may invalidate the Warranty.

- A. The warranty period commences from the date the goods are purchased.*
- B. All warranty claims must be processed through the Dealer from whom the equipment was purchased. The Dealer will co-operate with the purchaser throughout the warranty claims procedure and will arrange any necessary repairs using genuine Numatic parts.*
- C. If the original Dealer is no longer able to fulfil his obligations please contact Numatic International Limited with full details of the claim and proof of purchase so that this may be processed without delay.*
- D. Any warranty claim can only relate to the specific part that is proven to be at fault and for which a replacement will be supplied but cannot be extended to constitute a claim against the complete machine.*
- E. Numatic International will supply the Dealer with any warranty parts required, subject to the claim being validated, after return of the faulty items in accordance with Numatic International Limited's General Conditions of Sale.*
- F. Claims will not be accepted if they are the result of fair wear and tear, misuse or abuse of any kind.*
- G. No replacement will be given unless the appropriate evidence of the validity of the claim has been provided to the satisfaction of Numatic International Limited.*
- H. Numatic International Limited reserve the right to charge for any unnecessary work carried out as a result of an invalid claim.*
- I. No variation to this warranty may be made or implied by any member of Numatic International Limited or its Dealers unless such variation is in writing and authorised by the Company*



Numatic International Limited, Chard, Somerset, TA20 2GB

Telephone: 01460 68600 Fax: 01460 68458

© Numatic International Limited

Heads		Drums	
598140	WV.570-2 - EUROPEAN HEAD	500976	WV 900 (C/W LOWER HANDLE)
598417	WV.570-2 - UK HEAD	500720	WV/WVD1800 PLUS DRAIN HOSE
598284	WV.570-2 - (110 VOLT)	500385	WV570 + CASTORS
598180	WV.570-2 - SWISS	500721	1800 BLUE PUMP OUT (SMALL PUMP) (230V/50HZ)
598235	WVD.570-2 - EUROPEAN HEAD	500722	1800 BLUE PUMP OUT (SMALL PUMP) (120V/60HZ)
598217	WVD.570-2 - UK HEAD	500723	1800 BLUE PUMP OUT(SMALL PUMP) (120V/50HZ)
598841	WVD.570-2 - (110 VOLT)	500913	1800 BLUE PUMP OUT (LESS PUMP / HOSE)
598435	WV.900-2 - EUROPEAN HEAD	Cables	
598146	WV.900-2 - UK HEAD	236010	1MM X 3 CORE (SOCKET + PLUG) UK
598441	WV.900-2 - (110 VOLT)	236014	1MM X 3 CORE (SOCKET + PLUG) EURO
598142	WVD.900-2 - EUROPEAN HEAD	236018	1MM X 3 CORE (SOCKET + PLUG) SWISS
598143	WVD.900-2 - UK HEAD	236022	1MM X 3 CORE (SOCKET + PLUG) SOUTH AFRICA
598941	WVD.900-2 (110 VOLT)	236030	1MM X 3 CORE (SOCKET + PLUG) AUSTRALIAN
598328	WVD.900-2 - SOUTH AFRICA	236011	1.5MM X 3 CORE (SOCKET + PLUG) UK
598257	WVD.1800DH-2 - EUROPEAN HEAD	236015	1.5MM X 3 CORE (SOCKET + PLUG) EURO
598062	WVD.1800DH-2 - UK HEAD	236019	1.5MM X 3 CORE (SOCKET + PLUG) SWISS
598105	WV.1800PH - UK HEAD	236023	1.5MM X 3 CORE (SOCKET + PLUG) SOUTH AFRICA
598000	WVD.1800PH-2 - UK HEAD	236031	1.5MM X 3 CORE (SOCKET + 16AMP PLUG) AUSTRALIAN
598153	WVD.1800AP-2 - EUROPEAN HEAD	236009	X 1MM X 2 CORE (SOCKET + PLUG) UK
598269	WVD.1800AP-2 - UK HEAD	236013	X 1MM X 2 CORE (SOCKET + PLUG) EURO
Filters/ Baskets/Floats		236017	X 1MM X 2 CORE (SOCKET + PLUG) SWISS
604145	WV 1800 SERIES TRASH BASKET	236021	X 1MM X 2 CORE (SOCKET + PLUG) SOUTH AFRICA
604116	PRIMARY PERMATEx FILTER	236029	X 1MM X 2 CORE (SOCKET + PLUG) AUSTRALIAN
502034	WV570 FLOAT ASSEMBLY	Hose	
500609	18 INCH FLOAT ASSEMBLY	604245	10M DISCHARGE HOSE FOR AP MACHINES
AP Type - Pump			
389120	110V/60HZ.(1800 DRUM)		
389121	230V/50HZ.(1800 DRUM)		
389123	220V/60HZ.(1800 DRUM)		
389126	110V/50HZ.(1800 DRUM)		

Numatic International Limited, Chard, Somerset, TA20 2GB, ENGLAND.

Telephone 01460 68600 Fax: 01460 68458

www.numatic.co.uk

Subject to change without prior notice.

Numatic International Limited 244000 / 08/18 (A11)