



Operating and Maintenance Manual

CONTENTS

Introduction	2
Operating Specifications	3
Working Envelope Diagram	3
Do's and Don'ts	4
Primary Components	5
Operating Procedures (Incl. Emergency Operation)	6-8
Maintenance Procedures	9-12
Castor Safety and Maintenance	13-15
Maintenance Frequency Summary	16
Transportation, Loading, Towing, Manoeuvring and Storage	17-18
Key Spare Parts	19
Decal Placement	20-22
Warranty Terms	23
Wind Rated Machine Operating Specifications	Appendix 'A'
Wind Rated Machine Operating and Safety Instructions	Appendix 'B'
Wind Rated Machine Additional Maintenance Instructions	Appendix 'C'
Machines with ATEX Certification	Appendix 'D'

INTRODUCTION

The Ecolift (referred to as “the machine” in this manual) is a simple, safe and efficient alternative to step-ladders, platform/podium steps and small scaffold towers. It does not require batteries (or charging) or connection to an electricity supply. It works by a unique, patented stored power mechanism which enables the platform to be elevated with very little effort by the operator.

It is designed for working internally on flat, level surfaces, and, as it has no batteries, electric motor, electrics or hydraulics, it is very ecologically friendly. It is ideally suited to working in a very wide range of applications from the very ‘clean’ environments of hospitals, food and drinks production facilities, pharmaceuticals and retail, to facilities maintenance, shop-fitting and indoor construction and even on zone 1/21 hazardous areas (If ATEX option is fitted).

It is suitable for any application provided it is used within its specified operating parameters. If used for applications such as sand blasting, welding, paint spraying or with any other hazardous materials, measures must be taken to ensure it does not become damaged in any way which may impair safety, or reliability. Additional protection for the operator may be required in some cases, which is the responsibility of the operator and/or the operator’s employer.

The purpose of this manual is to provide essential basic information required to operate and maintain the machine.

This is not a workshop manual. Please contact the manufacturer or their agent for specific operation or maintenance information if in doubt.

The health and safety of the operator or maintenance technician is the responsibility of the individual and/or their employer and not Power Towers Ltd.

OPERATING SPECIFICATIONS

Working Dimensions

Maximum working height:	4.20 m
Maximum platform height:	2.20 m
Platform dimensions:	850 mm (L) x 644 mm (W)
Working footprint:	1280 mm x 740 mm
Safe working load:	150 kg (1 person + tools)
Maximum manual force:	200 N
Maximum gradient for operation:	0 degrees
Maximum wind force:	Internal use only, 0 (zero) mph
Maximum wheel force:	155 kg (1.52 kN)
Maximum castor point load:	155 kg (1.52 kN)
Sound pressure level:	Less than 70dBA

Closed Dimensions

Length:	1280 mm
Width:	740 mm
Height:	1950 mm
Weight:	305 kg

Lift Cycles: Unlimited, subject to maintenance program being adhered to.

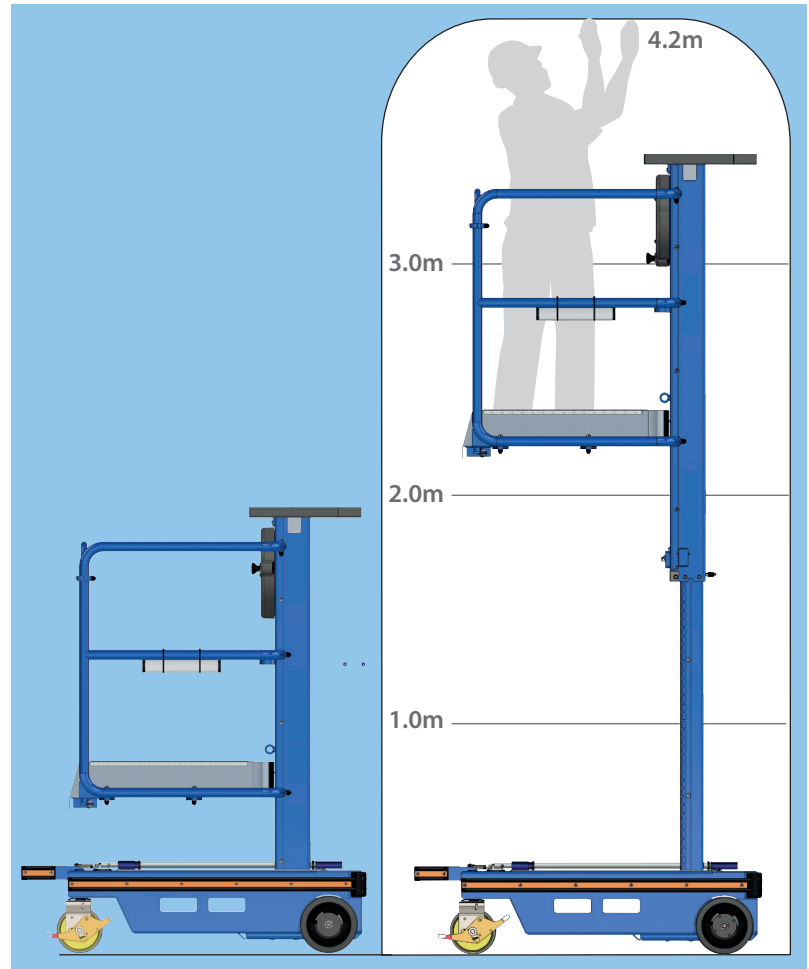

DO'S

1. Read, understand and adhere to the instructions on the machine and in the Instruction Guide or Operating Manual.
2. Ensure pre-operation checks & operations are carried out in the manner described.
3. Use only on hard, level surfaces able to support the weight of the machine.
4. Use the machine internally only.
5. Ensure the operator is fit and does not suffer from a fear of heights.
6. Ensure guardrail gates are closed before elevation.
7. Ensure work area around the machine is cordoned off from pedestrians and other traffic.
8. Ensure operator is wearing the correct safety equipment.
9. Ensure the platform is correctly positioned so as not to come into contact with fixed or moving objects.
10. Ensure that the safe working load is evenly distributed on the platform.
11. Ensure the machine is being operated within the PUWER (Provision and Use of Workplace Equipment Regulations).
12. Ensure the castor brakes are applied when leaving the machine unattended.

DON'TS

1. Never exceed the safe working load 150kg (1 person plus tools).
2. Never use the machine as a goods lift or crane.
3. Never exceed horizontal forces, (maximum horizontal force 200N).
4. Never use in the vicinity of live conductors.
5. Never try to move the machine on its wheels when elevated.
6. Never extend the height of the platform by using boxes, steps, ladders etc.
7. Never modify the machine in any way without the full written approval of the manufacturer.
8. Never attempt to enter or exit the platform unless it is fully lowered.
9. Never use the machine on sloping or uneven ground.
10. Never operate the machine outdoors, or anywhere it may be affected by wind.
11. Never lift heavy components on the machine without the use of the correct lifting equipment.
12. Never use the machine in an explosive environment.
13. Never use the machine if you are fatigued.
14. Never use the machine inappropriately or for 'horseplay'.
15. Never use the machine if under the influence of drugs or alcohol.
16. Never use the machine if suffering from poor health or using medication which might impair the safe operation of the machine.
17. Never use the machine if vision is impaired by bright lighting.
18. Never push the machine on sloping surfaces without the use of a safe method.
19. Never push or pull objects with the platform.
20. Never use on uneven surfaces.

PRIMARY COMPONENT LOCATIONS

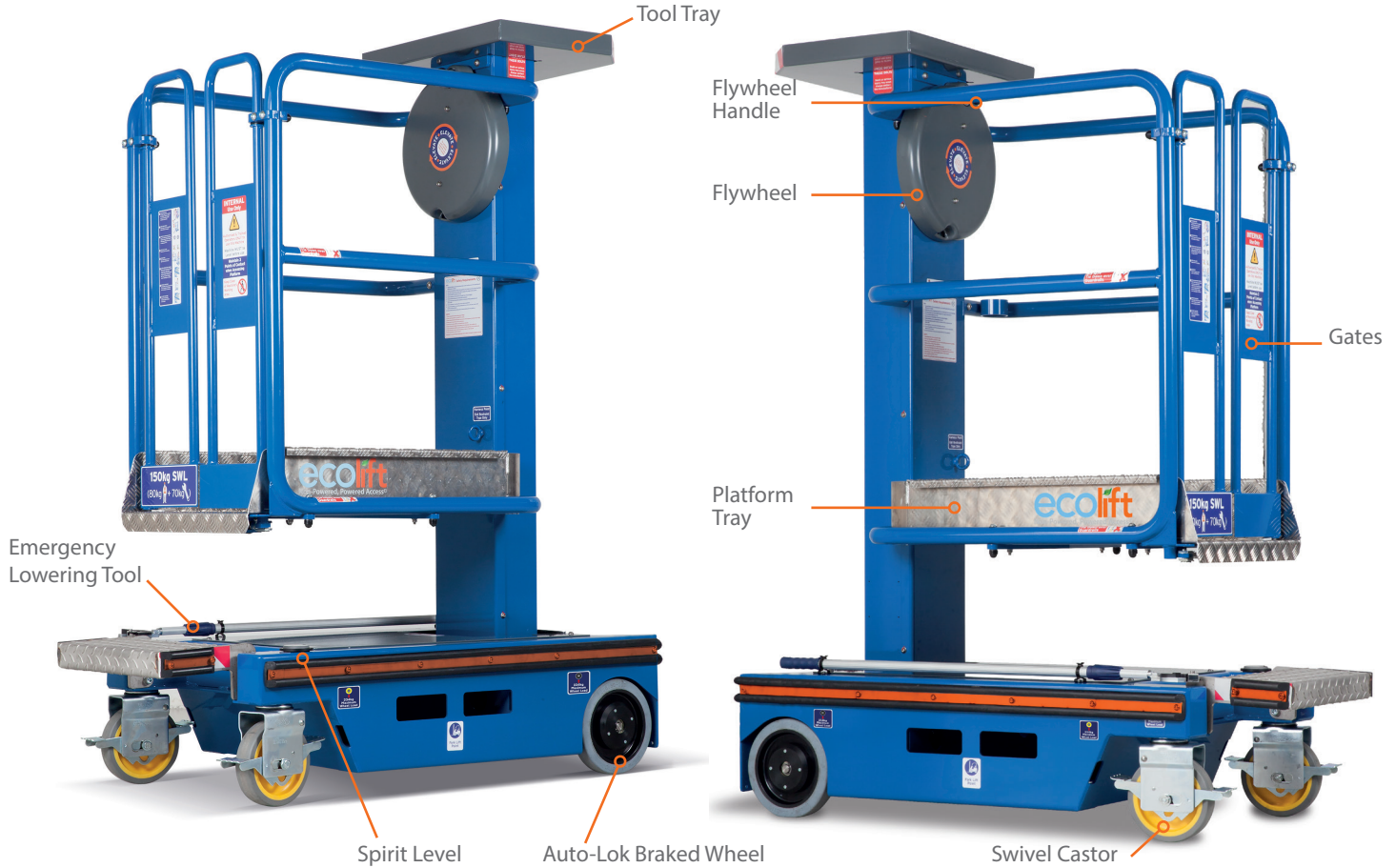

OPERATING PROCEDURES

It is the owners and/or the users responsibility to ensure that the machine is maintained and operated in accordance with the operation and maintenance procedures contained within this manual.

It is essential to be familiar with the correct operating procedures. The operator must have adequate training for this type of platform.

The machine is fitted with a safety harness point. If after conducting a risk assessment the operator chooses to wear a safety harness, an approved 'fall restraint' type harness should be worn with a very short lanyard.

Operating procedures are divided into three key areas:

1. **Pre-operation checks.**
What to do before operating the machine.
2. **Normal operation.**
How to use the machine safely.
3. **Emergency operation.**
How to lower the machine in the event of operator incapacity.



PRE-OPERATION CHECKS

1. Visually inspect the machine for any signs of damage to handrails, platform tray, chassis and mast lifting structure including mast fixing bolts.
2. Check castors and wheels rotate freely and are undamaged.
3. Check castor axle bolts (Pic 1) and wheel split pins (Pic 2) are secure.
4. Check spirit level (Pic 3) is intact and bubble is centred to ensure machine is level.
5. Check gates, gate hinges, hinge springs and hinge fixings are undamaged, and that gates fully open and fully self close when released (Pic 4).
6. Ensure step is lowered and secure.
7. Check castors are not loose or distorted in any way. If okay, lock by stepping on the pedal marked 'lock' or stepping on the red pedal, depending on which castor is fitted, then step into the basket.
8. When standing in the basket: check 'fly-wheel' operating handle works correctly. Hold handle firmly and pull operating knob towards you, release, knob should spring back to lock wheel. Repeat but turn handle once clockwise with knob held pulled towards you. Wheel should turn freely. Turn once anti-clockwise to come down (Pic 5).
9. Check emergency lowering tool is attached to the chassis and is not damaged.

If any of the above items are faulty or do not work correctly then do not use the machine.

NORMAL OPERATION

Only use the machine internally, on hard level surfaces. Ensure a person is available at ground level to assist in case of emergency.

1. Position machine under application.
2. Check spirit level to ensure machine is level.
3. Ensure castors are in the locked position as described in pre-operation checks.
4. Step into platform through gates, ensure gates close behind you.

DO NOT ELEVATE IF THEY ARE NOT CLOSED.

5. Check there are no overhead obstructions.
6. To elevate: pull operating knob towards you and turn clockwise.
To stop, stop turning the handle and release handle knob to lock.
7. To descend repeat but turn handle anti-clockwise.

Note: Only turn the flywheel handle when standing within the platform guardrails. Never operate when standing outside the guardrails, except when following the "Emergency Lowering Procedure."

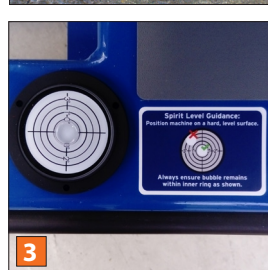

The user shall obtain the guidance and approval of the manufacturer in the event of any special working methods or conditions outside those specified by the manufacturer.

EMERGENCY LOWERING OPERATION

Never attempt to recover the machine/operator if there is any possibility the machine is contacting any live wiring/cabling and is therefore potentially 'live'.

Never operate the emergency lowering without a person in the platform otherwise serious injury may result.

The Emergency Lowering Procedure is for lowering the platform from height with an incapacitated operator in the platform and for no other purpose.

1. Locate emergency lowering tool on chassis (Pic 1), remove from fixing. If tool is held captive with tie-wrap safety tag then break tag to release tool.
2. Stand to side of machine, attach 'hook' end of emergency lowering tool to flywheel handle knob in basket, releasing handle knob, turn wheel **anti-clockwise** to bring platform down (Pic 2).
3. Keep clear of structure as it descends.
4. When lowered, always remove the lowering tool first before removing the person in order to lock the platform in a stationary position.
5. Depending on the height of the elevated platform, it may be necessary to extend the shaft of the tool.

Turn the shaft lock anti-clockwise to extend and retract the shaft, and clockwise to lock to the desired position.

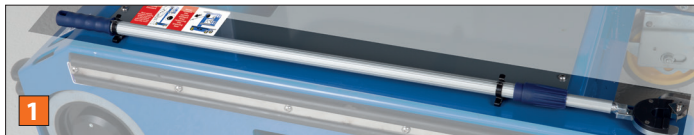

Turn wheel **anti-clockwise** to bring platform down

Please note that whilst the machine is extremely simple to maintain, all work must be carried out by a competent person.

NOTE: PUWER (The Provision and Use of Workplace Equipment Regulations 1998) stipulates that suppliers such as hire companies must ensure their equipment is maintained correctly and fully serviced. Once on site, it is the hirer/ employer's responsibility to ensure the machine remains in serviceable condition. The hirer/employer must also ensure the operator is properly trained and familiarised with the machine and the manufacturer's operating procedures.

The health and safety of any operator or maintenance staff is the responsibility of the individual and/or their employer.

DAILY MAINTENANCE

Note: The telescopic mast is a sealed unit which contains a pressurised cylinder and can only be dismantled by a trained person authorised by the manufacturer.

The most important regular maintenance to be carried out by the operator is visual inspection, as per the pre-operation checks.

Daily Checks

The safety critical items to inspect each work session, daily as a minimum are:

1. Check there is no damage to the following: wheels and castors and check that their fixings are secure. These are the components

that connect the machine to the ground; if they are damaged then operating the machine could be dangerous and may result in serious injury.

2. Check that the guardrails are not damaged and all fixings are secure.
3. Check gates and gate hinges are secure and gates fully self close when released. Ensure gates cannot open outwards.
4. Check chassis is not damaged and spirit level is intact and working.
5. Check mast fixings are all present and secure.
6. Check flywheel handle operates correctly: step into the platform to do this (do not attempt to operate the handle from outside the basket). Pull flywheel handle knob towards you, release. Ensure handle springs back to lock wheel. Turn wheel one revolution clockwise then anti-clockwise; ensure handle moves freely in either direction.
7. Check automatic wheel-brake works by: Ensure the castor brakes are unlocked, repeat no. 6 when platform is elevated approximately 100mm, and with the assistance of a colleague, attempt to push the machine, machine should not move, wheels should be braked.
8. Check emergency lowering tool is attached to chassis and not damaged.

Monthly Checks

As daily checks (items 1-8).

SIX MONTHLY CHECKS - LOLER

1. In order to inspect the internal mechanisms of the machine the following covers must be removed; tool tray (Pic A), mast cap plate (Pic B, shows mast cap after tool tray is removed) and handle cover (Pic C). Remove the tool tray using a 5mm allen key, then remove the mast cap plate using a 6mm allen key. The mast cap screws (Pic B, arrowed) are additionally secured with a threadlock adhesive. If difficulty is experienced removing these screws then they will need to be heated with a heat gun for a few minutes. Remove the handle cover using a special 5mm allen key, which can be obtained from the manufacturer or his agent.
2. Inspect and lubricate gearwheels. Use Omega 73 no. 2 harsh environment grease or equivalent. Do not use standard gear grease because it will dry out prematurely and will lead to premature gear wear.
3. Elevate the platform approximately 20mm so the back of the belt clamp bracket and the two countersunk fixing screws are visible. Looking through the inspection hole (Pic D, boxed), check the two screws are secure. Look inside the mast section from the top to the rear of the clamp (Pic E), and ensure the two nuts are secure.

Raise and lower the platform fully and inspect the drive belt whilst doing so with the aid of a suitable light. Ensure the belt remains on the top pulley (Pic F, arrowed), bottom pulley (Pic G, arrowed) and drive cog. If it is found difficult to view the lower pulley it may be necessary to look through the gap above the mast roller (Pic H, circled). To do so remove the mast roller cover, located underneath the platform, by slackening the two M12 nuts and pulling the cover off (Pic I, shows cover removed and lower pulley, arrowed).

Minor scuffing and wear of the belt surfaces, and visible steel braided wires, is acceptable. However, there must be no signs of wear or fraying of the steel braided wires. If the steel braided wires are worn or frayed, please contact the manufacturer.

Inspect the belt retaining plate (Pic J, arrowed). Ensure that the belt retaining plate does not move when the mast is raised and lowered.

When the internal inspection is complete, refit the mast cap plate and refit screws with medium strength threadlock. Paint seal the screws. Refit the handle cover and refit screws with medium strength threadlock. Paint seal the screws. Refit the tool tray. It is extremely important that all of these screws are replaced correctly.

4. Check the mast interlock is undamaged and is working correctly. Check the casing for signs of damage and remove the end plate (Pic K, arrowed). Insert a large flat screwdriver (300mm long approx.) between the stop screw and the lower pulley block (Pic L, arrowed) and lever downwards by applying a force of no more than 10kg. Care must be taken as applying too much force will damage the stop screw. When moving the block, watch the end of the interlock bolt (Pic M, arrowed) and ensure it moves inward and outward as the block is moved down and up. Refit cover and screw. Paint seal screw when refitted.
5. Inspect condition of automatic wheel lock. Look under brush strip at rear of chassis when platform is elevated so that mast outer is clear of chassis. Check brake cam plates (Pic N and Fig A, page 12) are undamaged and that the two attaching screws are tight. With an assistant to lower the platform, observe the action of the cams and the movement of the brake pins. Ensure the movement is free and the pins clear the wheel discs. When the platform is elevated ensure the pins fully engage the brake discs. Ensure the pockets in the wheels are in good condition.

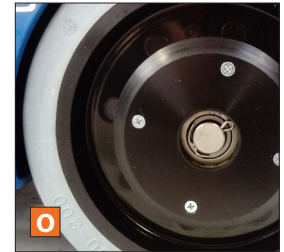
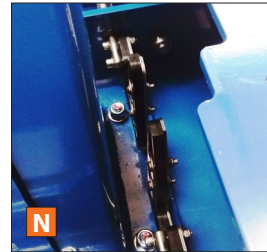
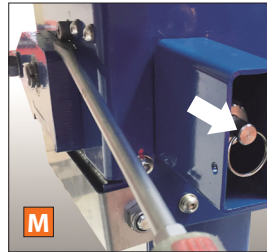
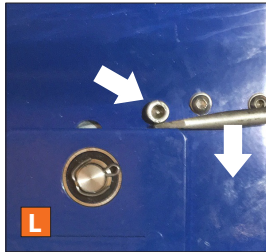
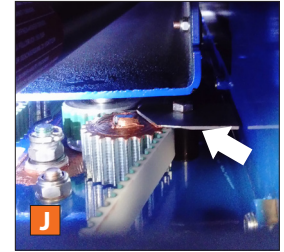
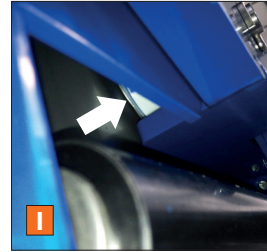
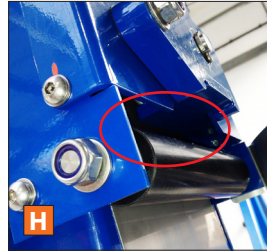
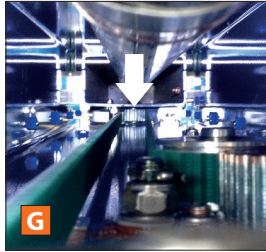
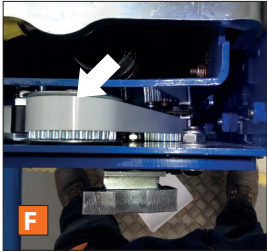
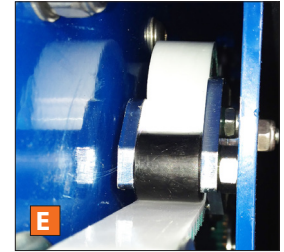
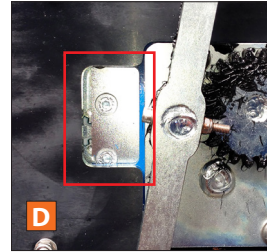
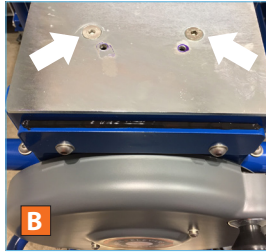
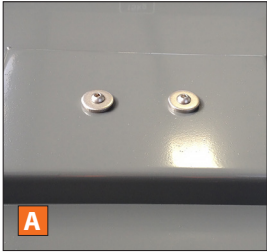

6. Ensure platform entrance gates open and close freely and that they self-close when released. Check pivots and springs for signs of fatigue and damage.
7. Check crank handle knob is securely fixed with M12 nyloc nut and roll pin through plastic tip. Ensure handle springs back to the locked position freely.
8. The machine should be subjected to the test procedure below:
 - a) Fully lower platform to the transport position.
 - b) With a calibrated digital spring balance apply a further 25kg force to the drive handle in the anti-clockwise direction (lowering), first releasing the handle knob from the back plate to allow the handle to turn (Fig B).
9. Check rear wheels for signs of damage and that they rotate freely. Ensure there is no cut or wear to tyre that penetrates more than 4mm in depth. The original wheel diameter is 200mm. Check the split pin retaining the rear wheels is undamaged and secure (Pic O).
10. Check castor condition in accordance with the following procedures shown on pages 13,14 and 15. Refer to the machine serial number to determine which procedure to follow.
11. Visually inspect the condition of the emergency lowering tool ensuring that it is not damaged or bent in any way and that it is securely clipped to the chassis.
12. Check all instruction labels are present and clear. Refer to the key spare parts. Check aluminium specification plate is clear and legible.

When replacing components for any reason, only use OEM specification parts, either supplied from the manufacturer or authorised in writing by the manufacturer. Warranties and design approvals will be void if alternative components are fitted. It is essential to obtain manufacturer's approval of any alteration which might affect stability, strength or performance in writing before proceeding.

When refitting a rear wheel always use a new cotter pin (4mm diameter x 32mm A2 stainless steel). NEVER REFIT A USED COTTER PIN.

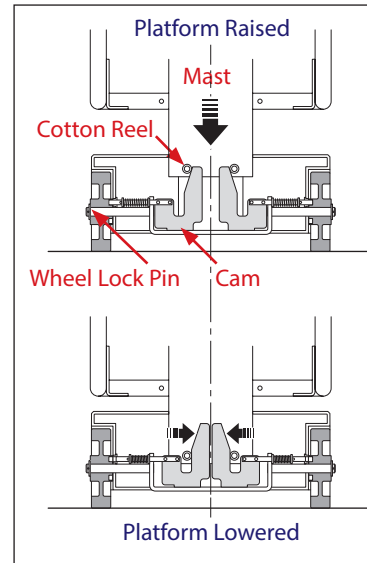

Fig A

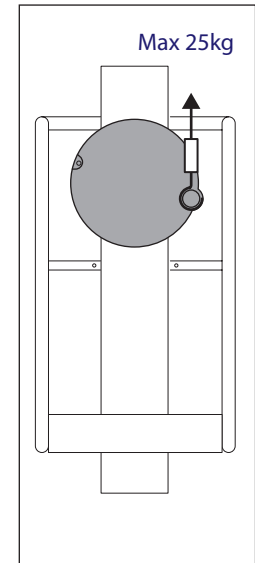

Fig B

Important.

These instructions apply to all machines FROM serial no. 8872815H (NOT including 9522915H, 9532915H, 9542915H, 9552915H, 10093115H).

CASTOR SAFETY & MAINTENANCE

In order to ensure the castors are maintained in safe, serviceable condition, regular inspection is required, especially where arduous conditions are known to be involved or there is a suspicion of misuse or abuse. The other key element to ensure is in a safe, serviceable condition is the castor fixing bolt, the condition of which can usually be determined from the condition of the castor bracket.

The castor is highly rated for the application so if visible distortion is evident a significant impact will have occurred and under these conditions the castor and fixing bolt must be replaced.

Typical signs of impact which would require castor and fixing replacement:



Foot pedal distortion as a result of a significant impact; it is likely the top plate and bearing will be distorted as well.

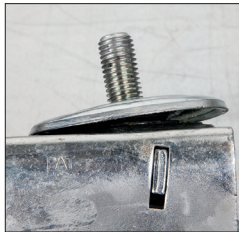

Mounting plate distortion as a result of a single significant impact or multiple lower level impacts. **Even if the rest of the castor is in good condition, it must be replaced.**

It may be thought feasible to repair the castor in a number of these instances, but serious structural damage will have occurred to the head bearing and castor assembly as well as possibly damage to the main fixing bolt. **THE CASTOR AND FIXING BOLT MUST BE REPLACED.**

When inspecting a castor in order to determine its serviceability, pay particular attention to the head swivel bearing (compare to a new one if possible) and the boss/rivet which goes through the centre of the swivel bearing and which clamps the assembly together.

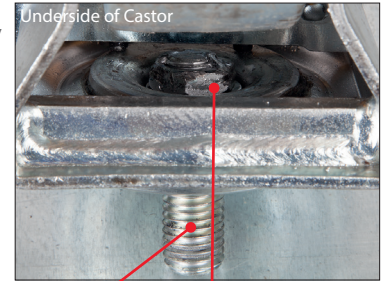

Castor fixing bolt

Swivel bearing head should feel free to rotate and not loose

Castor Fixing Bolt (3/4 UNC):
Castor Axle Bolt:

Torque - 120 Nm
Torque - 40 Nm

Important.

These instructions apply to all machines **BEFORE** Serial no. 8872815H (also including 9522915H, 9532915H, 9542915H, 9552915H, 10093115H).

CASTOR SAFETY & MAINTENANCE

In order to ensure the castors are maintained in safe, serviceable condition, regular inspection is required, especially where arduous conditions are known to be involved or there is a suspicion of misuse or abuse.

When inspecting the castor, pay particular attention to the head swivel bearing and the castor fixing bolt which goes through the centre.

The castor is highly rated for the application so if visible distortion is evident a significant impact will have occurred and under these conditions the castor and fixing bolt must be replaced (see fitting procedure, adjacent, for PT-M-102 Replacement castor and fixings kit).

If the castor is in good condition, with no visible distortion, then only the castor fixings need to be replaced (refer to page 15 for fitting procedure for PT-M-170 Replacement castor fixings kit).

Typical signs of impact which would require castor and fixing replacement:



Side impact and foot pedal distortion as a result of a significant side impact.



Foot pedal distortion as a result of a significant frontal impact; it is likely the top plate and bearing will be distorted as well.



Top mounting plate distortion as a result of a single significant impact or multiple lower level impacts.

Even if the rest of the castor is in good condition, it must be replaced.

It may be thought feasible to repair the castor in a number of these instances, but serious structural damage will have occurred to the head bearing and castor assembly as well as possibly damage to the main fixing bolt. THE CASTOR AND FIXING BOLT MUST BE REPLACED.

FITTING PROCEDURE FOR PT-M-102 REPLACEMENT CASTOR AND FIXINGS KIT

Kit comprises of;

- 1 off Castor with M12x60 Hex head bolt 10.9 BZP
- 1 off M12 Nyloc nut grade 10 BZP
- 2 off M12 Disc spring (also known as Belleville washer)

1. Raise the machine with a suitable jack, hoist or forklift.
2. Undo and remove the castor fixing nut and remove the castor from the machine. Discard the castor, M12 fixing bolt, M12 nyloc nut and all washers.
3. Fit the new castor to the machine.
4. Fit the 2 off disc springs, making sure that they are correctly orientated so that there is no gap between the outer edges of the disc spring and there is a gap between the inner edges of the disc spring, as shown.



FIT DISC SPRINGS LIKE THIS



DO NOT FIT DISC SPRINGS LIKE THIS



5. Fit the new nyloc nut and torque to 80Nm.
6. Check that the castor swivels freely, and lower the machine to the ground.
7. Check the castor rolls freely and apply the castor brake by operating the foot pedal.
8. Apply pushing force to the machine and check that this is resisted by the castor brake.



**Castor Fixing Bolt (M12):
Castor Axle Bolt:**

**Torque - 80 Nm
Torque - 40 Nm**

Power Towers Limited strongly recommends replacing any castor assembly or fixing bolt that is over 3 years old with a new one.

FITTING PROCEDURE FOR PT-M-170 REPLACEMENT CASTOR FIXINGS KIT

Kit comprises of;

Castor axle fixings

2 off M12 Washer form C

1 off M12 Lock nut grade 10 BZP

1 off M12 Shakeproof washer

1 off M12x90 Hex head bolt 10.9 BZP

Chassis fixings

1 off M12 Nyloc nut grade 10 BZP

1 off M12x60 Hex head bolt 10.9 BZP

2 off M12 Disc spring (also known as Belleville washer)

1. Loosen the castor axle bolt while the machine is on the ground.
2. Raise the machine with a suitable jack, hoist or forklift.
3. Remove the castor axle bolt, axle spacer and axle lock nut and remove the wheel. Discard the old castor axle bolt and axle lock nut. Do not discard the axle spacer or wheel.

4. Undo the castor fixing nut and remove the castor frame from the machine. Discard the old castor fixing nut, castor fixing nut and washer.
5. If there is a thin spacer washer present between the castor swivel head and the chassis then remove and discard it.

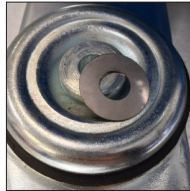

6. Fit the new castor fixing bolt to the castor frame, and then refit the castor frame to the machine.
7. Fit the 2 off disc springs, making sure that they are correctly orientated so that there is no gap between the outer edges of the disc spring and there is a gap between the inner edges of the disc spring, as shown.



FIT DISC SPRINGS LIKE THIS



DO NOT FIT DISC SPRINGS LIKE THIS



8. Fit the new nyloc nut and torque to 80Nm.



9. Refit the wheel, axle spacer and new axle bolt, washers, shakeproof washer and lock nut, applying some high strength threadlock (Loctite 648) to the lock nut.

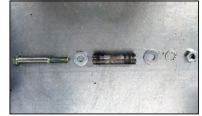

10. Torque the lock nut to 40Nm.



11. Check that the castor swivels freely, and lower the machine to the ground.
12. Check the castor rolls freely and apply the castor brake by operating the foot pedal.
13. Apply pushing force to the machine and check that this is resisted by the castor brake.

**Castor Fixing Bolt (M12):
Castor Axle Bolt:**

**Torque - 80 Nm
Torque - 40 Nm**

Power Towers Limited strongly recommends replacing any castor assembly or fixing bolt that is over 3 years old with a new one.

MAINTENANCE FREQUENCY SUMMARY

The table below summarises the frequency of checks that must be carried out on the machine, as detailed on pages 9 to 15.

MAINTENANCE FREQUENCY TABLE			
Item	Daily	Monthly	6 Monthly (LOLER)
Wheels & Castors	●	●	●
Guardrails	●	●	●
Gates	●	●	●
Spirit Level	●	●	●
Mast Fixings	●	●	●
Flywheel Handle	●	●	●
Auto-Lok Braked Wheels	●	●	●
Emergency Lowering Tool	●	●	●
Visual Inspection	●	●	●
Gearwheel Lubrication			●
Crank Handle Force			●
Crank Handle Knob Operation			●
Drive Belt			●
Mast InterLock			●
Castor Bolt Torque			●
Instruction Labels			●

TRANSPORT INSTRUCTIONS

It is the responsibility of the transport driver to ensure the machine is safely secured to the transport vehicle.

Ensure that the transport vehicle has the load capacity and dimensions in order to safely carry the weight and size of the machine.

Ensure that loading straps/chains are of adequate capacity to safely secure the machine for transport.

Always ensure that the machine is transported in the upright position. Never lay flat.

Ensure the transport vehicle is parked on a level surface and the parking brake is applied.

The machine can be loaded via a forklift, tail-lift, or winch. Never push the machine up a slope without the aid of a winch.

If using a forklift, raise the machine by approximately 50 - 100mm so that the front wheel brakes engage.

Ensure the castor wheel locks are operated and that the forklift tines are fully engaged through the chassis sockets.

Load the machine onto the transport vehicle, taking care to position the machine so that straps can be located around the base of the machine without the need for the driver to have to climb onto the bed of the vehicle. Note; only trained qualified forklift drivers are to load the machine.

Use at least two straps, with one strap over the chassis, around the mast section and out to the rear of the machine. The other strap should be fed through the front of the chassis and the straps taken forward, so that the machine is tied down in four diagonal directions. Never place the strap over the platform or handrails.

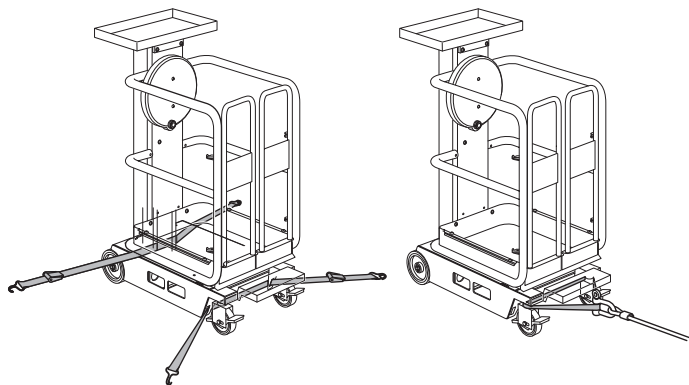

LOADING

If loading with the aid of a winch up a ramp to the trailer, connect the winch cable to the castor/gate end of the chassis around the tops of the swivel castors, and then connect the winch cable to the strap.

Ensure the castor brakes are unlocked, and that the platform is fully lowered in the transport position. Before disconnecting the machine from the winch cable, engage the castor brake.

If loading with the aid of a tail lift, ensure the tail lift has adequate load capacity and dimensions in order to safely lift the machine. Ensure the tail lift and vehicle is on flat ground.

Ensure the platform is fully lowered to the transport position and wheel onto the tail lift bed. Once correctly positioned on the bed, lock the swivel castor brakes.

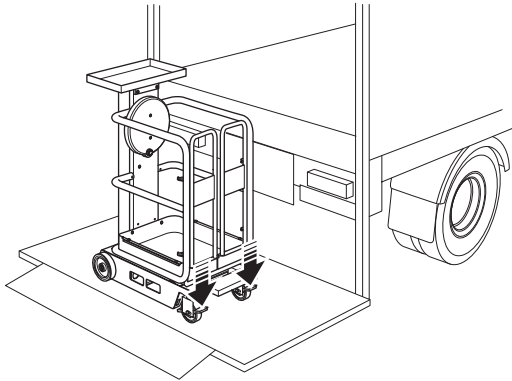

Raise the tail lift to the vehicle bed height. Unlock the castors and manoeuvre to the desired location on the vehicle and tie down as described above.

TOWING

It is the responsibility of the driver to ensure safe practice is employed in order to access the vehicle bed to manoeuvre the machine and then tie it down. One option is for the vehicle to be fitted with suitable guarding to prevent the possibility of the driver from falling to the ground.

HOW TO MANOEUVRE

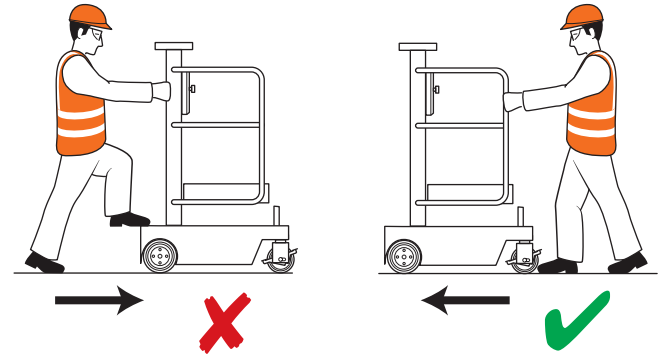

STORAGE

If the machine is due to be stored for periods in excess of one month, the following precautions should be taken: ensure the machine is fully lowered and ideally place a cover over the machine.

Only store or transport the machine in an upright position.

Upon removal from storage and prior to returning to use, ensure machine pre-operation checks are carried out thoroughly, check LOLER certificate is current.

	Part No.	
A	Swivel Castor*	PT-M-102
B	Swivel Castor**	PT-M-102-2
C	Spirit level	PEL-M-451
D	Wheel	ECL-M-600
E	Tool Tray	ECL-M-601
F	Chassis Cover	ECL-M-602
G	Handle cover	ECL-M-603
H	Gates (pair)	ECL-M-700
I	Step	ECL-M-701
J	Emergency Lowering Tool	ECL-M-703
K	Platform Tray	ECL-M-704
L	Decal Set 1	ECL-M-800
M	Decal Set 2 (Ecolift)	ECL-M-802

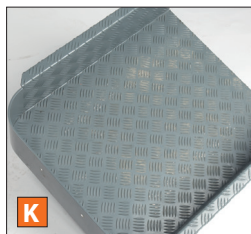
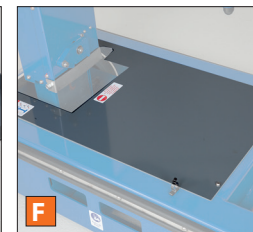
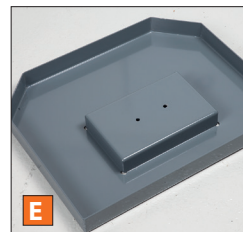
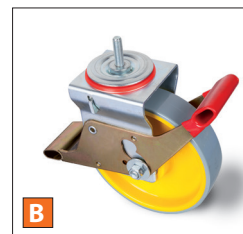
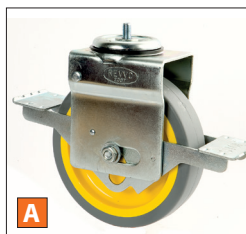

CASTOR CHANGES:

* (PIC A) BEFORE SERIAL NO. 8872815H
(also including 9522915H, 9532915H,
9542915H, 9552915H, 10093115H)

** (PIC B) FROM SERIAL NO. 8872815H
(Not including 9522915H, 9532915H,
9542915H, 9552915H, 10093115H).

DECAL PLACEMENT



Picture	Description	Decal Location
1.	A. 15 kg Maximum load	Inside tool tray, front face
2.	A. Do not tie down over guardrails, x 4	Each side of cage near gates, upper and middle guardrails
3.	A. 155 kg Maximum wheel load, x 4	Left and right side of chassis, 2 each side, next to wheels
	Note: For Wind Rated machine, use 160 kg Maximum wheel load (decals are on same sheet)	
	B. Fork lift point, x 2	Left and right side of chassis, below forklift openings
	C. Lock castors before elevating, x 2	Left and right side of chassis, next to maximum wheel load
4.	A. Spirit level guidance	Next to spirit level
	Note: For Wind Rated machine, use wind rated spirit level guidance (decals are on same sheet)	
	B. Lifting & tie-down point, x 2	Front of chassis, next to lifting & tie-down points
5.	A. Emergency lowering procedure	Rear of chassis
	B. Hand trap point	Rear of chassis, next to brush strip
	C. Specification plate	Bottom of mast, external face
6.	A. Lifting & tie-down point, x 2	Rear of chassis, next to lifting & tie-down points
7.	A. Operating Instructions	Left gate, upper panel
	B. Use advisory decal	Right gate, upper panel
	Note: For Wind Rated machine, remove the "Internal use only" part of the decal before applying to machine	
	C. Safe Working Load 150 kg	Left gate, lower panel
	D. Safety guidelines	Middle of mast, internal face
	E. Harness point	Above harness point

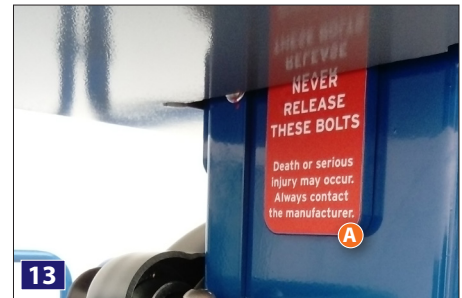

Picture	Description	Decal Location
8.	A. Do not enter the area underneath...	Middle of mast, internal face
9.	A. Product logo, x 2	Left and right side of platform tray
10.	A. Elevate	Centre of handle cover
11.	A. Keep mast surfaces clean...	Middle of mast, external face
12.	A. Hazard tape	Tool tray
13.	A. Never release these bolts..., x 2	Both sides of mast, below tool tray

WARRANTY

Your Ecolift or Ecolift WR (The Machine) is covered by a parts and components warranty as stated in the purchase terms and conditions.

The Manufacturer, Power Towers Ltd (The Company), undertakes to replace or repair, free of charge, any defective part or component which the company considers to be due to faulty workmanship or material, within the warranty period, except for:

The telescopic mast is a sealed unit. If the mast is opened in any way warranty may be invalid.

Defects arising from neglect, misuse or unauthorised modifications.

Damage caused by abuse, misuse, dropping or other similar damage caused by or as a result of failure to follow transportation, storage, installation, loading or operation instructions.

Alterations, additions or repairs carried out by persons other than the Manufacturer or their recognised distributors.

Transportation or shipment costs to and from the Manufacturer or their recognised agents, for repair or assessment against a warranty claim, on the machine or component.

Materials and/or labour costs to renew, repair or replace components due to fair wear and tear.

Faults arising from the use of non-standard or additional parts, or any consequential damage or wear caused by the fitting or use of such parts.

IMPORTANT

Warranty may, at the sole discretion of the Manufacturer, be voided if the scheduled service/inspections are not carried out in accordance with this manual.

The Manufacturer and/or their recognised agents, directors, employees or insurers will not be held liable for consequential or other damages, losses or expenses in connection with or by reason of or the inability to use the machine for any purpose.

MODIFICATIONS

If additional equipment or any third party work, modifications or alterations are to be carried out on the machine which will involve any welding, drilling or any form of cutting or distortion of materials, full written approval must be obtained from the Manufacturer prior to the work being carried out.

OPERATING SPECIFICATIONS FOR WIND RATED MACHINE

Working Dimensions

Maximum working height:	4.20 m
Maximum platform height:	2.20 m
Platform dimensions:	850 mm (L) x 644 mm (W)
Working footprint:	1280 mm x 950 mm
Safe working load:	150 kg (1 person + tools)
Maximum manual force:	200 N
Maximum gradient for operation:	3 degrees
Maximum wind force:	Internal/External, 12.5 m/s
Maximum wheel force:	160 kg (1.57 kN)
Maximum castor point load:	160 kg (1.57 kN)
Sound pressure level:	Less than 70dBA

Closed Dimensions

Length:	1280 mm
Width:	950 mm
Height:	1950 mm
Weight:	340 kg

Lift Cycles

Unlimited, subject to maintenance program being adhered to.



Wind Rated machine is operable on gradients up to 3° and in winds up to 12.5m/s

DO'S

1. Read, understand and adhere to the instructions on the WR machine and in the Instruction Guide or Operating Manual.
2. Ensure pre-operation checks & operations are carried out in the manner described.
3. Use only on hard, level surfaces up to 3° able to support the weight of the WR machine.
4. Ensure the operator is fit and does not suffer from a fear of heights.
5. Ensure guardrail gates are closed before elevation.
6. Ensure work area around the WR machine is cordoned off from pedestrians and other traffic.
7. Ensure operator is wearing the correct safety equipment.
8. Ensure the platform is correctly positioned so as not to come into contact with fixed or moving objects.
9. Ensure that the safe working load is evenly distributed on the platform.
10. Ensure the WR machine is being operated within the PUWER (Provision and Use of Workplace Equipment Regulations).
11. Ensure the castor brakes are applied when leaving the WR machine unattended.

DON'TS

1. Never exceed the safe working load 150kg (1 person plus tools).
2. Never use the WR machine as a goods lift or crane.
3. Never exceed horizontal forces (maximum horizontal force 200N).
4. Never use in wind exceeding 12.5m/sec.
5. Never use in the vicinity of live conductors.
6. Never try to move the WR machine on its wheels when elevated.
7. Never extend the height of the platform by using boxes, steps, ladders etc.
8. Never modify the WR machine in any way without the full written approval of the manufacturer.
9. Never attempt to enter or exit the platform unless it is fully lowered.
10. Never lift heavy components on the WR machine without the use of the correct lifting equipment.
11. Never use the WR machine in an explosive environment.
12. Never use the WR machine if you are fatigued.
13. Never use the WR machine inappropriately or for 'horseplay'.
14. Never use the WR machine if under the influence of drugs or alcohol.
15. Never use the WR machine if suffering from poor health or using medication which might impair the safe operation of the WR machine.
16. Never use the WR machine if vision is impaired by bright lighting.
17. Never push the WR machine on sloping surfaces without the use of a safe method.
18. Never push or pull objects with the platform.
19. Never use on surfaces over a 3° gradient.

OPERATING PROCEDURES

It is the owners and/or users responsibility to ensure that the Ecolift WR (referred to as “the WR machine” in this manual) is maintained and operated in accordance with the operation and maintenance procedures shown in Appendices A, B & C, in addition to the operation and maintenance procedures shown on pages 1 to 22 of this manual.

It is essential to be familiar with the correct operating procedures. The operator must have adequate training for this type of platform.

The WR machine is fitted with a safety harness point. If after conducting a risk assessment the operator chooses to wear a safety harness, an approved 'fall restraint' type harness should be worn with a very short lanyard.

PRE-OPERATION CHECKS

1. Visually inspect the WR machine; check for signs of damage to structure including castors, wheels, operating handle.
2. Position the WR machine safely; ensure there are no overhead obstructions or dangers.
3. Ensure ground conditions are suitable. The WR machine should be used on hard, level surfaces up to 3° that will support the WR machine and safe working load.
4. Ensure castors are locked before entering platform.
5. Check operating handle is working correctly by stepping into basket through gates, ensure gates are fully closed behind you; gently pull handle knob towards you, release: handle knob should spring back to prevent handle turning. Do not use the WR machine if handle knob is damaged or sticking.
6. Cordon off work area in accordance with guidelines.
7. Safe working load for the WR machine is 1 person only plus tools with a total of 150kg including person. Never exceed the safe working load.

NORMAL OPERATION

1. The WR machine must only be used on hard surfaces not sloping more than 3°. Ensure a person is available at ground level to assist in case of emergency.
2. Position the WR machine under application. Check for any overhead obstructions or dangers.
3. Check spirit level on the WR machine chassis to ensure the WR machine is level up to 3°. Do not use the WR machine unless bubble remains within 3° circle.
4. To use the WR machine, step into platform through gates. Ensure gates are fully closed behind you. Gently pull operating handle knob towards you; turn handle clockwise to elevate. Always check for overhead obstructions or dangers. To stop elevation: stop turning handle; release handle knob. Turn handle anti-clockwise (counter-clockwise) to descend.

Never attempt to move the WR machine when elevated.

EMERGENCY LOWERING OPERATION

Never attempt to recover the WR machine/operator if there is any possibility the WR machine is contacting any live wiring/cabling and is therefore potentially 'live'.

Never operate the emergency lowering without a person in the platform otherwise serious injury may result.

The Emergency Lowering procedure is for lowering the platform from height with an incapacitated operator in the platform and for no other purpose.

1. Remove emergency operation tool located on chassis. If tool is held captive with tie-wrap safety tag then break tag to release tool.
2. Follow instructions on Emergency Lowering Procedure instruction label and on page 8 of this manual.

WHEELS AND CASTORS

It is absolutely essential that the wheels and castors are maintained in good condition at all times, for two reasons:

The first is that they act as the stabilisers, and whilst their load capacity is over rated for the application, any failure could result in a serious accident. Secondly, if the bearings become tight, then it will make the machine difficult to manoeuvre.

A measure of horizontal push force can simply be made to determine the condition of the wheel bearings. On a flat smooth surface the WR machine should move with a force of 9 – 10 kg at the mid guard rail height. The maximum allowance is 20 kg. Obviously this force is dependant upon the surface and gradient, but the above is the recognised method of measurement, in accordance with HSE guidelines.

Check rear wheels to ensure retention cotter pin is securely fitted and undamaged.

When replacing components for any reason, only use OEM specification parts, either supplied from the manufacturer or authorised in writing by the manufacturer. Warranties and design approvals will be void if alternative components are fitted. It is essential to obtain manufacturer's approval of any alteration which might affect stability, strength or performance in writing before proceeding.

**When refitting a rear wheel always use a new cotter pin (4mm diameter x 32mm A2 Stainless Steel).
NEVER REFIT A USED COTTER PIN.**

MACHINES WITH ATEX CERTIFICATION

The Ecolift and Ecolift WR can be specified as ATEX approved, for zones 1 and 21. This comes with third party approval by SGS Baseefa (Certificate no. Baseefa 13ATEX0150).

There are no elements of the machine which were identified as a potential hazard.

There are no specific additional maintenance procedures required for the ATEX certified machine except to ensure that the earthing strap is intact, and it is in contact with the ground.



www.powertowers.com



100% British designed
and manufactured.