

STAR 8 - STAR 22J - STAR 10 - STAR 26J

Operator's manual

STAR 8 - STAR 22J
STAR 10 - STAR 26J

4000357590

10.17

USA / GB



A**FOREWORD**

1 - User responsibility	8
1.1- Owner's responsibility.....	8
1.2- Employer's responsibility.....	8
1.3- Trainer's responsibility	8
1.4- Operator's responsibility.....	9
2 - Safety	10
2.1 - Safety instructions.....	10
2.1.1 - Misuse Hazards	10
2.1.2 - Falling Hazards	11
2.1.3 - Overturning / Tip-over Hazards	12
2.1.4 - Electrocution Hazards	15
2.1.5 - Explosion / Fire Hazards.....	16
2.1.6 - Crushing / Collision Hazards	16
2.1.7 - Uncontrolled movement Hazards	18
3 - Safety inquiries	19
4 - Incident notification	19
5 - Compliance	20
5.1 - Product information	20
5.1.1 - Change of Ownership Notification	20
5.1.2 - Owner information update form	21
5.2 - Product specifications	22

B**FAMILIARIZATION**

1 - General safety	23
1.1 - Intended use	23
1.2 - Decal content	24
1.3 - Symbols and colors	25
1.4 - Level of severity	25
1.5 - Symbols legend and definitions.....	26
2 - Models description	27
3 - Primary machine components	28
3.1 - Layout	28
3.2 - Ground control box	30
3.2.1 - Layout	30
3.2.2 - ACTIV'Screen	32
3.3 - Platform control box	38
3.3.1 - Layout	38
4 - Performance Specifications	41
4.1 - Technical characteristics	41
4.2 - Working area / Range of motion	43
5 - Decals and markings locations	44

CONTENTS

C**PRE-OPERATION INSPECTION**

1 - Recommendations	57
2 - Working area assessment	58
3 - Inspection and Functional test	59
3.1 - Daily inspection	59
4 - Safety functional checks	63
4.1 - E-Stop button check	63
4.2 - Activation of controls	64
4.3 - Fault detector	64
4.3.1 - Buzzers test	64
4.4 - Overload sensing system (if fitted)	64
4.5 - Slope warning device	65
4.6 - Travel speed limitation	65
4.7 - Electronic variable speed drive	65
4.8 - Machine braking	66
4.9 - Pothole protection system	66
4.10 - On-board charger	66
4.10.1 - Battery charge level	66

D**OPERATION INSTRUCTIONS**

1 - Operation	67
1.1 - Introduction	67
1.2 - Operation from a control box	67
2 - Ground control box	68
2.1 - To start and stop the machine	68
2.2 - Mast movement controls	68
2.3 - Additional controls	68
3 - Platform control box	69
3.1 - To start and stop the machine	69
3.2 - Drive and steer control	69
3.3 - Mast movement controls	70
3.4 - Additional controls	70
4 - Emergency procedure	71
4.1 - In case of power loss	71
4.1.1 - Mast manual lowering procedure	71
4.1.2 - Jib manual lowering procedure	72
4.2 - To rescue operator in platform	73
4.3 - Manual emergency lowering procedure	75



5 - Transportation	77
5.1 - Putting in transport position	77
5.2 - Machine layout	77
5.3 - Unloading	78
5.4 - Towing	78
5.4.1 - Electric brake release	79
5.5 - Storage	80
5.6 - Loading by ramp	81
5.7 - Unloading by ramp	81
5.8 - Lifting operation	81
5.8.1 - Loading and unloading	81
5.8.1.1 - Safety precautions	82
5.8.1.2 - Necessary equipment	82
5.8.1.3 - Preliminary procedures	82
5.8.1.4 - Procedure for the use of slings	83
5.8.2 - Lifting operation with tie-down points on the mast	83
5.8.2.1 - Safety precautions	84
5.8.2.2 - Necessary equipment	84
5.8.2.3 - Preliminary procedures	84
5.8.2.4 - Procedure for the use of slings	85
5.9 - Loading and unloading with forklift	86
6 - Hydraulic oil	87
7 - Battery care and maintenance	88
7.1 - Centralized battery refilling	88
7.2 - Battery charging	88

E

GENERAL SPECIFICATIONS

1 - Machine dimensions	92
2 - Major component masses	94
3 - Acoustics and vibrations	94
4 - Wheel/Tire assembly	95
4.1 - Technical specifications	95
4.2 - Inspection and maintenance	95
5 - Options	97
5.1 - Activ' Shield Bar - SECONDARY GUARDING SYSTEM (If fitted)	97
5.1.1 - Description	97
5.1.2 - Characteristics	98
5.1.3 - Safety precautions	99
5.1.4 - Pre-operation inspection	100
5.1.5 - Operation	100
5.1.6 - Specific decals	101

CONTENTS



F**MAINTENANCE**

1 - General	103
2 - Maintenance Schedule	104
3 - Inspection program	105
3.1 - General program	105
3.2 - Daily inspection	106
3.3 - Periodic inspection	106
3.4 - Reinforced inspection	106
3.5 - Major inspection	107
4 - Repairs and adjustments	108

G**OTHER INFORMATION**

1 - Warranty disclosure	109
1.1 - After Sales Service	109
1.2 - Manufacturer's warranty	109
1.2.1 - Warranty acceptance	109
1.2.2 - Warranty period	109
1.2.3 - Procedure conditions	109
1.2.4 - Conditions of warranty	110
2 - Subsidiary contact information	112
2.1 - California warning	113



A - Foreword

You have just purchased a HAULOTTE® product and we would like to thank you for your business.

The Aerial Work Platform is a mechanical device primarily designed and manufactured with the intent to position people with the necessary tools and material to overhead elevated temporary workplaces. All other uses or alterations/modifications to the aerial work platform must be approved by HAULOTTE®.

This manual shall be considered a permanent component of the machine and shall be kept with the aerial work platform in the designated Manual Holder, at all times.

Safe operation of this product can only be assured if you follow the operating instructions contained in this manual. To ensure proper and safe use of this equipment, it is strongly recommended that only trained and authorized personnel operate and maintain the aerial work platform.

We would particularly like to draw your attention to 2 essential points :

- Comply with safety instructions.
- Use the equipment within the specified/published performance limits.

With regard to the designation of our equipment, we stress that this is purely for commercial purposes and not to be confused with the technical specifications. Only the specifications in this manual should be used to study the suitability of the equipment for the intended use.

This operator's manual is specific to the HAULOTTE® products listed on the cover page of this manual.



Original language and version :

Manuals in English and French are the original instructions. Manuals in other languages are translations of the original instructions.

The operator's manual does not replace the basic training required for equipment operators. HAULOTTE® has compiled this manual to assist in safe and efficient operation of the products covered in the manual.

The manual must be available to all operators and must be kept in a legible condition. Additional copies can be ordered from HAULOTTE Services®.

Stay Safe and keep working with HAULOTTE® !

A - Foreword

1 - User responsibility

1.1 - OWNER'S RESPONSIBILITY

The owner (or hirer) has the obligation :

- To inform operators of the instructions contained in the Operator's Manual.
- For applying the local regulations regarding operation of the machine.
- To replace all manuals or decals that are either missing or not legible. Additional copies can be ordered from HAULOTTE Services®.
- To establish a preventive maintenance program in accordance with the manufacturer's recommendations, taking into account the environment and severity of use of the machine.
- To perform periodic inspections in accordance with HAULOTTE® recommendations and local regulations.

All malfunctions and problems identified during the inspection shall be corrected before the aerial work platform is returned to service.

1.2 - EMPLOYER'S RESPONSIBILITY

The employer has the obligation :

- To authorize the operator to use the machine.
- To inform and familiarize the operator with the local regulations.

Forbid anyone from operating the machine if :

- Under the influence of drugs, alcohol, etc.
- Subject to fits, loss of motor skills, dizziness, etc.

1.3 - TRAINER'S RESPONSIBILITY

The trainer must be qualified to provide training to operators in accordance with applicable local regulations. The training must be given in an obstacle-free area until the trainee is considered competent as defined by the training program undertaken.

A - Foreword

1.4 - OPERATOR'S RESPONSIBILITY

The operator has the obligation to :

- Read and understand the contents of this manual and familiarize himself with the decals affixed on the machine.
- To inspect the machine before use according to HAULOTTE®'s recommendations..
- To inform the owner (or hirer) if the manual or any decals are missing or are not legible.
- To inform of any malfunctioning of the machine.

The operator shall ensure that frequent inspections were conducted by the owners and the operator may only operate the machine for the purpose intended by the manufacturer.

Only authorized and qualified operators may operate HAULOTTE® machines.

All operators must become familiar with and fully understand the emergency controls and be able to operate the machine in an emergency.

The operator has the obligation to stop using the machine in the event of malfunction or safety problems on the machine or in the work area and report the problem immediately to his/her supervisor.

A

B

C

D

E

F

G

H

I

A - Foreword

2 - Safety

2.1 - SAFETY INSTRUCTIONS

2.1.1 - Misuse Hazards

- Do not use the machine for any other purpose than to position people, their tools and material to the overhead/elevated temporary work places.
- Do not use the machine as a crane, material lift or elevator. Only use the machine as it was intended.
- Do not attach overhanging loads when raising or lowering the platform.
- Do not tie the boom or platform to an adjacent fixed or mobile structure.
- Do not use/operate the machine when alone. A survey person or immediate Supervisor must be present on the ground in case of emergency.
- Do not use a faulty or poorly maintained machine. Remove defective/damaged machine from service.
- Do not climb onto the compartment covers of the machine.
- Do not replace items critical to machine stability with items of different weight or specification.
- Do not replace factory-installed tires with tires of different specifications or ply rating.
- Do not alter or disable machine components that in any way affect safety and stability.
- Do not disable the safety devices.



A - Foreword

2.1.2 - Falling Hazards

To enter or exit from the platform :

- The machine must be completely stowed.
- Face the machine to access the entry opening to the platform.
- Keep 3 points of contact (both hands and a foot) on the steps and the guardrail.



Before commencing operation :

- Ensure that guard rails are correctly installed and secured.
- Ensure that gate or sliding bar is in its proper closed position.
- Remove oil or grease from the steps, floor, handrail and the guardrails.
- Clear the platform floor free of debris.



When in the platform :

- Occupants must wear a fall arrest harness with lanyard and energy absorber, in accordance with applicable governmental regulations. Attach the lanyard to the designated fall arrest anchor provided in the platform.
- The correct use of the harness requires the lanyard to be connected to an anchorage point designated by the decals. Refer to this decal located on the platform.
- Hold on securely to the guardrails.
- Always keep your feet firmly on the floor of the platform.
- Do not sit, stand, or climb on the platform guard rails.
- Work only within the platform guardrails area and do not lean over guardrails to perform work.
- Do not exit the platform until it is in the completely stowed position.
- Do not use the guardrail as a means of access to climb in or out of the platform.



A - Foreword

2.1.3 - Overturning / Tip-over Hazards

Before positioning and operating the machine :

- Ensure that the surface is capable of supporting the machine weight including the rated capacity.
- Do not exceed the maximum rated capacity that includes the weight of both material and allowed number of occupants. Do not exceed the allowable number of occupants.
- Place the loads uniformly distributed on the platform floor.
- Do not increase the working height (using extensions, ladder, etc.).
- Do not place ladders or scaffolds in the platform or against any part of this machine.
- Do not use the machine in winds exceeding the permissible limit.
- Do not increase the surface area of the platform exposed to wind. This includes adding panels, mesh, banners. Be aware when working with materials with a large surface area. This will add to the wind load on the machine.
- Do not raise the platform or drive with platform elevated on an incline exceeding the rated slope for the machine.
- Do not drive the machine on slopes or grades exceeding the specified limits.
- Do not replace components critical to stability with components of different weight or specification.
- Do not use the machine with material or objects hanging from the guardrail or the boom.
- Do not pull or push towards any object outside of the platform. Do not exceed the maximum allowable side force stated in the performance specifications.
- Do not use the machine to support any external structure.
- Do not use the machine to tow other machines or to drag materials.



A - Foreword

Using a machine on a slope

If the tilt alarm sounds with the platform uphill : **First lower the mast and then retract the mast.**



Do not exceed the slope limit for each operation.  **Section B 4.1 Technical specifications.**

Gradeability :

- Driving UP or DOWN a slope in stowed position.

Sideslope :

- Driving in stowed position across a slope.

Rated slope :

- Operating with platform elevated.



- If the tilt alarm sounds with the platform facing downhill : First retract the mast and then lower the mast.
- While driving, always place the jib in the direction of movement.
- While driving on a slope:
 - Always orientate the machine in the direction of the slope.
 - Always place the mast and the jib in fully retracted and in stowed position.
 - Do not travel down slopes in high speed.
 - Do not drive fast in narrow or cluttered areas. Keep speed under control while making turns or sharp bends.

WIND : The aerial work platform can operate up to a maximum wind speed as indicated in the specifications. To identify the local wind speed, use the Beaufort scale below, use a wind gauge or an anemometer.

A

B

C

D

E

F

G

H

I

A - Foreword

N.B.:-The Beaufort scale of wind force is accepted internationally and is used when communicating weather conditions. A wind speed range at 10 m (32 ft 9 in) above flat, clear land is associated with each degree.

Beaufort scale

Force	Meteorological description	Observed effects	m/s	km/h	mph
0	Calm	Smoke rises vertically.	0 - 0,2	0 - 1	0 - 0,62
1	Very light breeze	Smoke indicates the wind direction.	0,3 - 1,5	1 - 5	0,62 - 3,11
2	Light breeze	Wind felt on the face. Leaves rustle. Weather vanes turn.	1,6 - 3,3	6 - 11	3,72 - 6,84
3	Slight breeze	Leaves and small twigs in constant motion. Flags move slightly.	3,4 - 5,4	12 - 19	7,46 - 11,8
4	Nice breeze	Raised dust and loose papers. Small branches are moved.	5,5 - 7,9	20 - 28	12,43 - 17,4
5	Nice breeze	Small trees in leaf to sway. Crested wavelets form on inland waterways.	8,0 - 10,7	29 - 38	18,02 - 23,6
6	Cool wind	Large branches in motion. Power lines and chimneys 'sing'. Umbrellas used with difficulty.	10,8 - 13,8	39 - 49	24,23 - 30,45
7	Near gale	Whole trees in motion. Inconvenience felt when walking against wind.	13,9 - 17,1	50 - 61	31 - 37,9
8	Gale	Some branches break. Generally we cannot walk against the wind.	17,2 - 20,7	62 - 74	38,53 - 45,98
9	Strong gale	The wind causes slight damage to buildings. Tiles and chimney stacks are blown off.	20,8 - 24,4	75 - 88	46,60 - 54,68

A - Foreword

2.1.4 - Electrocution Hazards

The machine is not electrically insulated and does not provide protection from contact or proximity to electrically charged conductors.

Always position the lift at a safe distance from electrically charged conductors to ensure that no part of the machine is within an unsafe area.

Respect the local rules and the minimum safety distance from power lines.

Minimum safe approach distances

Electric voltage	Minimum safety distance	
	Mètre	Feet
0 - 300 V	Avoid contact	
300 V - 50 kV	3	10
50 - 200 kV	5	15
200 - 350 kV	6	20
350 - 500 kV	8	25
500 - 750 kV	11	35
750 - 1000 kV	14	45

N.B.: - Use this table except where local regulations indicate otherwise.

- Do not operate the machine when close to live power lines, consider the movement of the machine and the sway of the electric power lines particularly in windy conditions.
- Do not operate the machine during lightning, thunderstorms, snow/ice or any weather condition that could compromise operator safety.
- Do not use the machine as a ground for welding.
- Do not weld on the machine without first disconnecting the battery terminals.
- Always disconnect ground cable first.
- The machine must not be used while charging the batteries.
- When using the platform AC power supply, ensure it is protected with a circuit breaker and residual current device.

Keep away from the machine if it contacts energized power lines. Personnel on the ground or in the platform must not touch or operate the machine until energized power lines are shut off.



A - Foreword

2.1.5 - Explosion / Fire Hazards

Always wear protective clothing and eye wear when working with batteries and power sources/systems.

N.B.:- Acid is neutralized with sodium bicarbonate and water.

- Do not work on or operate a machine in an explosive or flammable atmosphere / environment.
- Do not touch hot components.
- Do not bridge the battery terminals with metallic objects.
- Do not service the battery in proximity of spark, open flame, lit cigarettes.
- ALWAYS avoid contact with battery acid. Battery acid causes serious burns and should be kept away from skin or eyes. If contact occurs, flush with water and consult a physician immediately.



2.1.6 - Crushing / Collision Hazards

When in the platform :

- Check the work area for overhead clearance, for any obstacles besides and below the platform when raising/lowering the platform and or before driving.
- During movement, keep all the parts of the body inside the platform. Hold onto the guardrails and take care to avoid trapping of hands/fingers while holding on to the guardrails.
- To position machine close to a building/structure, use the jib movement control function to position, instead of driving machine closer to structure.
- Always cordon off the area around the base of the machine to keep personnel and other equipment away from the machine while in use.
- Warn personnel not to work, stand, or walk under a raised boom/platform.
- Do not drive in reverse direction (opposite the field of vision).
- Always ensure that the chassis is never driven any closer than 1 m (3 ft 3 in) to holes, bumps, slopes, obstructions, debris and ground coverings that may hide holes and other dangers.
- Keep non-operating personnel at least 5 m (16 ft 5 in) away from the machine when driving and slewing.

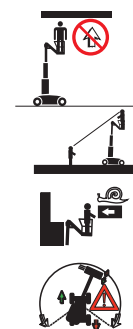

A - Foreword

- Be aware of driving direction.
 - When turret is slewed/rotated 180°, the platform is now facing the rear of the machine.
 - Check the driving direction with the help of the red or green arrow on the chassis relative to the red and green arrows on the platform control box.
 - Also note that when changing the driving direction (Forward <> Reverse) the joysticks or switches must return to the neutral position before reversing the drive direction and for movement to occur.
- When driving, position the platform so as to provide the best possible visibility and to avoid any blind spots.
- Hold on securely to the guardrails.
- Occupants must wear a fall arrest harness with lanyard and energy absorber, in accordance with applicable governmental regulations. Attach the lanyard to the designated fall arrest anchor provided in the platform.
- Avoid contact with fixed or mobile obstacles (other machines).
- Other machines (crane, aerial work platform, etc.) operating in the work area increase the risk of crushing or collision. Restrict the operation of machines moving within the aerial work platform work area.
- Take into consideration the stopping distance, reduced visibility and blind spots of the machine.
- Limit travel speed to suit the ground surface condition, slope (incline), and people in the vicinity.

A

B

C

D

E

F

G

H

I

A - Foreword

2.1.7 - Uncontrolled movement Hazards

Do not use a damaged or malfunctioning machine.

Be aware of uncontrolled movement and always respect the following :

- Maintain clearance from high voltage lines.
- Maintain clearance from generators, radar, electromagnetic fields.
- Never expose the batteries or electrical components to water (high pressure washer, rain).
- Never tow the machine over extended distances.
- In case of a machine breakdown, it is possible to tow short distance to load it onto a trailer.
- Never leave the hydraulic cylinders fully extended before switching off the machine, or when stationary for an extended period of time.
- Retract the mast and lower the jib to the stowed position.
- Select a safe parking location, on a firm level surface, clear of obstruction and traffic.
- Ensure all compartments are closed and secured.
- Chock the wheels.
- Operator must remove the foot from the footswitch when any movement has ceased (For Japan only).

A - Foreword

3 - Safety inquiries

Inquiries relating to design criteria/specifications of a product, standards compliance, or overall machine safety should be sent to the HAULOTTE® PRODUCT SAFETY department.

Each inquiry or request should include all relevant information; including contact name, telephone number, mailing address, email address, plus the machine model and serial number.

The HAULOTTE® Product Safety department will evaluate each request/inquiry and will provide a written response.

4 - Incident notification

Notify HAULOTTE® immediately when a HAULOTTE® product has been involved in an incident/accident leading to personal injury or death, or when there is a major property damage.

HAULOTTE Group - EUROPE Product Safety Department	HAULOTTE Group - Australia, India and Asia Product Safety Department	HAULOTTE Group - North & South America Product Safety Department
Address : La Péronnière - BP 9 - 42152 L'Horme - France	Address : No.26 Changi North Way - Singapore 498812 - Singapore	Address : 3409 Chandler Creek Rd. - Virginia Beach, VA 23453 - United States
Tel : +33 (0)4 77 29 24 24	Tel : +65 6546 0123	Tel : +1 757 689 2146
Email : ProductSafety@haulotte.com	Email : ProductSafety@haulotte.com	Email : ProductSafety@haulotte.com

A - Foreword

5 - Compliance

5.1 - PRODUCT INFORMATION

Without the written permission from Haulotte, modifying a HAULOTTE® product is a Safety concern. Any modification may violate Haulotte design parameters, government regulations and industry standards.

If you desire a modification to the product, submit a request in writing to HAULOTTE®.

With the utmost care to ensure enhanced reliability and greater safety of the HAULOTTE® products, it is pertinent that when a "Service or Safety Bulletin" is issued, action is taken immediately. Once the bulletin has been addressed, make sure that the completed form is submitted to HAULOTTE®.

Do not hesitate to contact HAULOTTE Services®, should you have any questions relating to the issued bulletin(s) or with questions on the policy itself.

5.1.1 - Change of Ownership Notification

It is important and necessary to keep HAULOTTE Services® updated with current ownership of the machine. This way, HAULOTTE® will be able to provide the necessary support for the product. If you have sold or transferred this machine(s); it is your responsibility to notify HAULOTTE Services®. It is not required to include Lessees/Renters of Leased/Rented machines on this form.

Use the HAULOTTE® Product Status Notification form to report scrapped, stolen, missing or recovered machine(s).

A - Foreword

5.1.2 - Owner information update form

Owner information update form	
Complete this form and mail or fax it to :	
HAULOTTE® subsidiary Name :	Address 1 :
Fax :	Address 2 :
e.mail address :	Address 3 :
Product information :	
Model :	Machine serial number :
Owner / Servicing information : Do not include leased or rented units in this form	
Current product owner 1 :	Current product owner 2 :
Name :	Name :
Company :	Company :
Address 1 :	Address 1 :
Address 2 :	Address 2 :
Country :	Country :
Phone :	Phone :
Date of ownership :	Date of ownership :
Signature :	Signature :
Date :	Date :
Company stamp is mandatory :	Company stamp is mandatory :
Tick here if the machine has been permanently removed from service (scrapped). The manufacturer's nameplate must be removed and returned to HAULOTTE Group when the unit is removed from service.	
Reason for removal :	

A

B

C

D

E

F

G

H

I

A - Foreword

5.2 - PRODUCT SPECIFICATIONS

HAULOTTE® cannot be held liable for any changes to the technical characteristics/specifications contained in this manual. HAULOTTE® has a continuous improvement policy in place for its product range. Given this policy, the Company reserves the right to modify products technical characteristics / specifications without notice.

Certain options can modify the machine's operating characteristics and its' associated safety. If your machine was originally delivered with options fitted, replacing a safety component associated with a particular option does not require any particular precaution other than those associated with the installation itself (static test).

Otherwise, it is essential to follow the manufacturer's recommendations as stated below :

- Installation by authorised HAULOTTE® personnel only.
- Update the manufacturer's identification plate.
- Have stability tests carried out by a certified agency/competent person.
- Ensure decals are updated.

B - Familiarization

1 - General safety

1.1 - INTENDED USE

To ensure the safe use of an Aerial Work Platform, support personnel must always be available on the ground. If necessary, support personnel will be required to operate the emergency functions of the machine and in rescuing the operator.

Do not operate the product in the following situations :

- On soft, unstable or cluttered ground.
- With wind blowing faster than the permissible limit.
 - Check the allowable wind speed specified in the performance specifications tabulation.
 - Consult the Beaufort scale.
- Close to power lines. Keep a safe distance.
- Outside of the temperature range -20°C / $+50^{\circ}\text{C}$ (-4°F / $+122^{\circ}\text{F}$).
- In an explosive atmosphere / environment.
- During storms.
- In the presence of strong electromagnetic fields.

N.B.: - Use the machine under "normal" climatic conditions. If you need to use the machine in climatic conditions likely to cause deterioration (extreme : humidity, temperatures, salinity, corrosiveness, atmospheric pressure), contact HAULOTTE Services®. Reduce intervals between servicing.

N.B.: - While the machine is not in use, care must be taken to bring the machine to the fully stowed position. Ensure that the machine is locked in a secure location, and the control key is removed to prevent unauthorised use of the machine.

B - Familiarization

1.2 - DECAL CONTENT

Decals are provided to alert the user of hazards inherent with the Aerial Work Platforms.

Decals provide the following information :

- The level of severity.
- The specific hazard.
- A method to avoid, suppress or reduce the hazard.
- Descriptive text (where required).

Familiarize yourself with the decals and the hazard severity levels.

CE and AS standards



ANSI and CSA standards



Marking	Description
1	Hazard symbol
2	Level of severity
3	Avoidance symbol pictorial
4	Avoidance text

Decals must be kept in good legible condition.

Familiarize yourself with the decals and their respective color codes.







Additional decals can be ordered from HAULOTTE Services®.

B - Familiarization











1.3 - SYMBOLS AND COLORS

Symbols and colors are used to alert the operator of safety precautions and/or to highlight important safety information.

The following safety symbols are used throughout this manual to indicate specific hazards and the hazard severity level when operating or maintaining the Aerial Work Platform.

Symbol	Description
	Danger : Risk of injury or death
	Caution : Risk of material damage
	Prohibited action
	Reminder to use good practice or follow pre-operation checks
	Cross-reference to another part of the manual
	Cross-reference to another manual
	Cross-reference to repair (contact HAULOTTE Services®)
N.B. :	Additional technical information

1.4 - LEVEL OF SEVERITY



































Color	Title	Description
		Danger : Indicates a hazardous situation which if not avoided, WILL result in death or serious injury.
		Warning : Indicates a hazardous situation which if not avoided, COULD result in death or serious injury.
		Caution : Failure to comply could result in minor or moderate injury.
		Notice : Indicates recommended practices if not followed, may result in a malfunction or damage the machine or its components.
		Procedure : Indicates a maintenance operation.

B - Familiarization

1.5 - SYMBOLS LEGEND AND DEFINITIONS

Symbols are used throughout this manual to depict hazards, avoidance measures and indicate when information is required.

Refer to the following table to familiarize yourself with these symbols.

Symbol	Description	Symbol	Description	Symbol	Description
			Foot crushing hazard		High pressure fluid ejection hazard
	Body crushing hazard		Hand crushing hazard		Entanglement hazard
			Health/safety hazards related to chemicals		Health-damaging effects from hot work environment
	Electrical contact or lightning strike		Burns and scalds from contact with flames, explosion or radiation from heat sources		Injury from Electric arcs - Energy supply disconnecting devices - Batteries fire, emissions, etc
	Risk of operator(s) falling		Tip over due to excessive loading / wind load and excessive ground slope		Relate and coordinate directional arrows on the chassis with those on the control box
	Do not put foot in this area		Do not put your hand in this area		Keep away from product working area
	Never expose batteries and electrical component to high pressure washer		Ensure entry drop rail is down		Overload
	Flames prohibited		Maintain safe clearance from high voltage electrically charged conductors as described in manual - Do not use in thunderstorms		Use appropriate lanyard attached to dedicated anchor point.
	Refer to operator manual		Safety belt		Use safety prop before attempting any maintenance work
	Wheel pressure		Enable switch		Lift point
	Tow point		Tie down point		
	Keep away from hot surfaces		Wear protective equipment		

B - Familiarization

2 - Models description

Regulations	Models
ANSI and CSA standards	STAR 22J STAR 26J
CE, AS and EAC standards	STAR 8 STAR 10

A

B

C

D

E

F

G

H

I

B - Familiarization

3 - Primary machine components

3.1 - LAYOUT

STAR 8 - STAR 22J - STAR 10 - STAR 26J

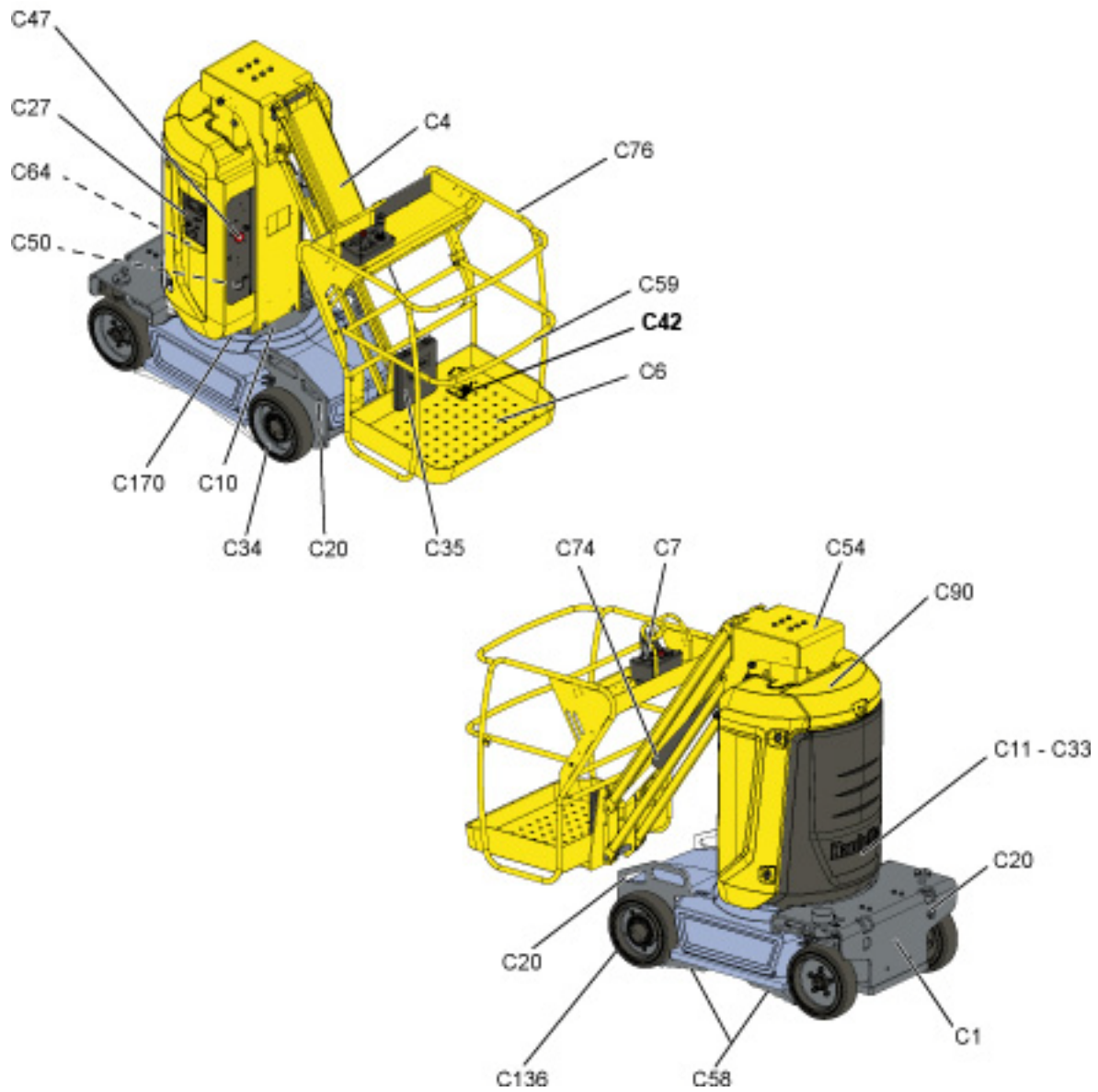

B - Familiarization

Marking	Description	Marking	Description
C1	Chassis	C47	Battery isolation switch
C4	Jib	C50	Battery charger socket
C6	Platform	C54	Telescopic mast
C7	Platform control box	C58	Pothole protection
C10	Slew ring	C59	Platform entry (hinged rail)
C11	Turntable assembly	C64	Tilt sensor
C20	Tie-down (and/or forklift loading)	C74	Jib leveling cylinder
C27	Ground control box	C76	Guardrail
C33	Counterweight	C90	Batteries pack
C34	Drive wheels	C136	Steer wheels
C35	Document holder	C170	Brake release switch
C42	Foot pedal switch (For Japan only)		

A

B

C

D

E

F

G

H

I

B - Familiarization

3.2 - GROUND CONTROL BOX

3.2.1 - Layout

General view



B - Familiarization

Controls and indicators

Marking	Name	Description	Function
15	SB801	E-stop button	Pulled out : E-stop activated Pushed in : E-stop deactivated
90		Battery charging indicator	Battery charger status
92	SA901	Control box activation key switch	Move upwards : Platform control box energized Center : De-energizes control system Move downwards : Ground control box energized
105		Beacon light ⁽¹⁾	Move to the right : Flashing light is turned on Move to the left : Flashing light is turned off
127	SA520	Mast telescoping selector	Move upwards : Mast extension Move downwards : Mast retraction
128	SA250	Turret rotation switch	Move to the left : Clockwise (CW) rotation Move to the right : Counter clockwise (CCW) rotation
129	SA620	Jib raising / lowering switch	Move upwards : Jib raising Move downwards : Jib lowering
253	CN03	Diagnostic tool socket	
258		Brake release telecommand connection ⁽²⁾	

(1.) For machines fitted with
(2.) For machines fitted with

A

B

C

D

E

F

G

H

I

B - Familiarization

3.2.2 - ACTIV'Screen

Upon starting and during operation of the machine, the LCD screen "Activ'Screen" located on the ground control box displays in real time the machine operating status.

Indicators

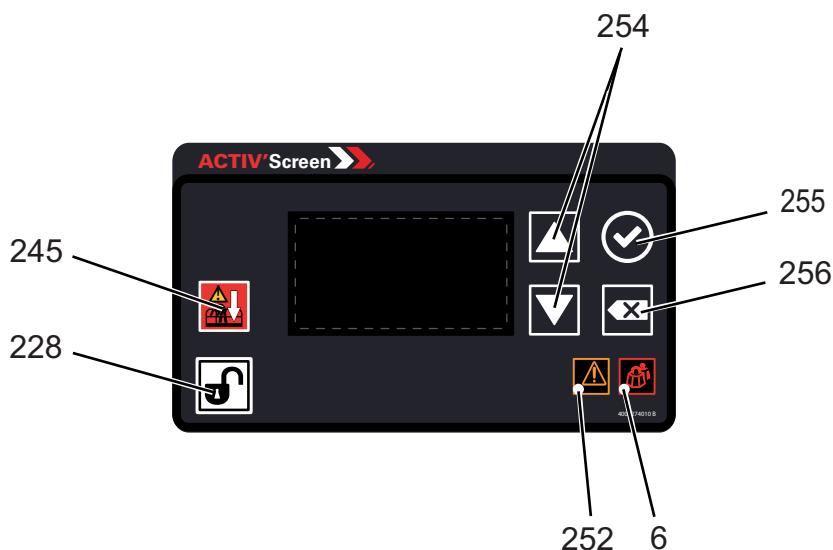





Controls and indicators

Marking	Description
6	Platform overload indicator : Intermittently lit in case of overload
228	'Enable Switch' selector : Press and hold 'Enable switch' button
245	"Overriding system" control : Emergency lowering system
252	Machine fault indicator : Intermittently lit in the event of an operation malfunction
254	Navigation buttons
255	Validation Button
256	Cancel Button

B - Familiarization

HAULOTTE Activ'Screen 2

Icon	Description	Function	Icon	Description	Function
HAULOTTE Activ'Screen 2					
					
Navigation buttons - Above Activ'Screen display					
	Up Navigation	Permits scrolling up through the screen (if present)		Cancel Button	Used to refuse or cancel a selection within the menu
	Down Navigation	Permits allows scrolling down through the screen and onto the following screen (if present)		Validation Button	Used to confirm selection within the menus

At startup with the ground or platform controls selected; system initiates a self check :

- Bar gets filled up.

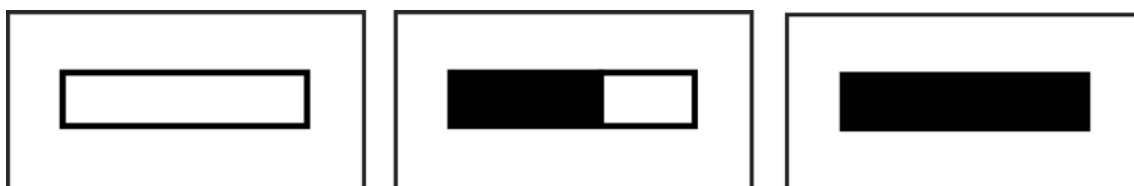

- Home screen comes on with status icon of the machine - okay to proceed functioning the controls.

B - Familiarization

Controls and indicators

Icon	Description	Function	Icon	Description	Function
Home screen (dashboard) (Will be visible - depending on the machine)					
1	Functional information zone			Battery status	• Display battery charge status
				Maintenance use	• Maintenance required display
				Alarm	• Alarm detected display
				Hourmeter	• Display total machine running hours
2	Information text		OPTIMUM 8	Machine Model	• The timer flashes if the engine is switched on and the hourmeter increases.
			READY	Ready	• Machine ready, displayed when no failures and no other machine state icons is active
			26/01/2014 10:15	Machine date and time	• Display machine date and time
3	Machine status zone			Machine ready	• Machine ready, displayed when no failures and no other machine state icons is active







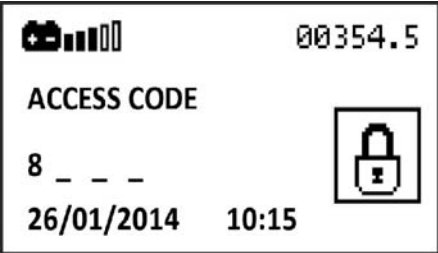

B - Familiarization

Controls and indicators

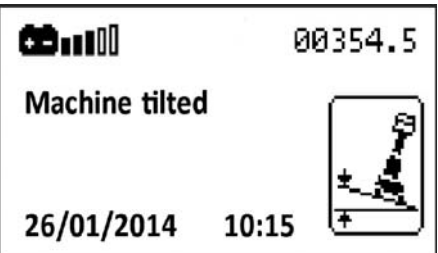

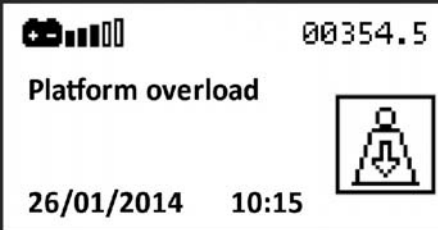
Icon	Description	Function	Icon	Description	Function
Home screen (dashboard) (Will be visible - depending on the machine)					
1	Information text		4000013540 STD	Software part number	• Display machine software code
2	Information text		V02.00.02.03	Software version + Screen software version + Screen version	• Display software version, screen software and screen version
3	Information text		SC021938 V01	Screen identification + Screen software version	• Display of screen ID and screen software version
4	Information text		S/N : 215623	Machine serial number	• Machine serial number displayed

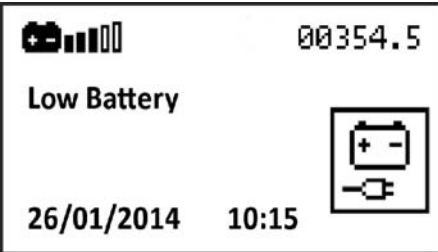
B - Familiarization

Controls and indicators

Icon	Description	Function	Icon	Description	Function
Home screen (dashboard) (Will be visible - depending on the machine)					
				Access code	<ul style="list-style-type: none"> • Access code screen comes on - refer to maintenance manual for entering the access code - Validation by pressing on is active only if access code is known and entered - refer to maintenance manual for the procedure for the different level code usage
				Tilt	<ul style="list-style-type: none"> • Display software version, screen software and screen
				Overload	<ul style="list-style-type: none"> • Display of screen ID and screen software version
				Low battery	<ul style="list-style-type: none"> • Machine serial number displayed

B - Familiarization

<p>  00354.5 F03-1312 Default Code 26/01/2014 10:15 </p>	<p>F03-1312</p>	<p>Present fault</p>	<ul style="list-style-type: none"> • Display machine fault code
<p>Upper Emergency St.</p>  		<p>Platform control box E-stop button pressed in (de-energized)</p>	<ul style="list-style-type: none"> • Displays if E-stop button pushed. Possible use of Overriding.

A

B

C

D

E

F

G

H

I

B - Familiarization

3.3 - PLATFORM CONTROL BOX

3.3.1 - Layout

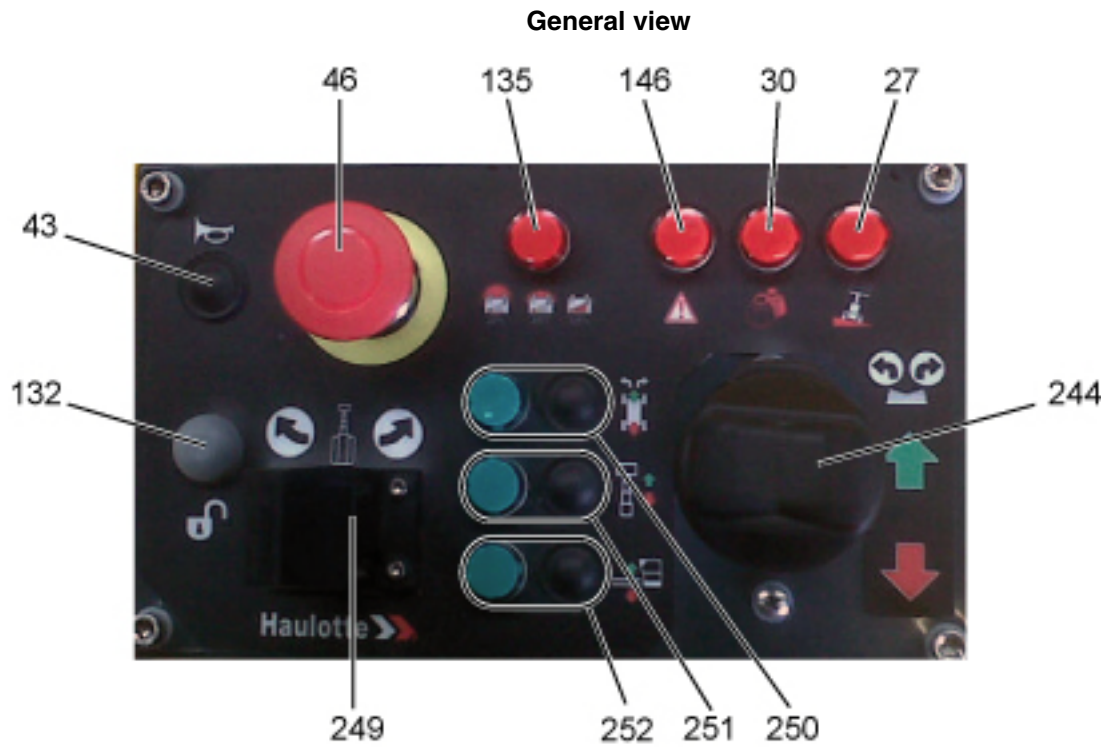

B - Familiarization

Controls and indicators

Marking	Name	Description	Function
27	HL800	Tilt indicator	Machine on excessive slope
30	HL802	Platform overload indicator	Platform overload
43	SA907	Horn button	Press and hold the horn button to sound the horn
			Sound stops when the horn button is released
46	SB802	E-stop button	Pulled out : Platform control box energized
			Pushed in : De-energizes control system
132	SA200	'Enable Switch' selector / Turret rotation control	Press in and hold : Validation of turret rotation selection
			Release : Cancellation of turret rotation selection
135	HL904	Battery charging indicator	 Battery charged
			 Flashing : Batteries have 40 % charge left
			 Constantly on : Batteries have only 20 % charge left
146	HL903	Machine fault indicator	Machine operating fault
244	SM901	Drive and steering joystick	Press in button (250) to select either the drive or steer movement
			Move forward : Forward drive
			Move backwards : Reverse drive
			Press right side of button : Right-hand steering
		Press left side of button : Left-hand steering	
		Press button (251) to select Mast extend / retract movement	
		Joystick as mast movement function	Move forward : Mast extension
Move backwards : Mast retraction			
249	SM902	Turret rotation selector	Press button (252) to select Jib raising or lowering movement
			Move forward : Jib raising
			Move backwards : Jib lowering
249	SM902	Turret rotation selector	Move to the right : Counter-clockwise turret rotation
			Move to the left : Clockwise turret rotation

B - Familiarization

Marking	Name	Description	Function
250	SA102	Drive and steer control	Pressed down (activated) : Movement selection (Without activating the joystick (244), under 8 s, the movement is cancelled.)
		Drive and steering indicator mode	On : Activated mode
251	SA500	Mast extension / retraction control	Pressed down (activated) : Movement selection (Without activating the joystick (244), under 8 s, the movement is cancelled.)
		Mast movement indicator mode	On : Activated mode
252	SA600	Jib raising / lowering control	Pressed down (activated) : Movement selection (Without activating the joystick (244), under 8 s, the movement is cancelled.)
		Jib movement indicator mode	On : Activated mode

B - Familiarization

4 - Performance Specifications

4.1 - TECHNICAL CHARACTERISTICS

Use the table to select the right Haulotte machine for the job.

CE, AS and EAC standards

Machine	STAR 8		STAR 10	
	SI	Imp.	SI	Imp.
Characteristics - Dimensions				
Maximum working height	8,75 m	28 ft 9 in	9,95 m	32 ft 8 in
Maximum platform height	6,75 m	22 ft 1 in	7,95 m	26 ft 1 in
Maximum horizontal reach	3,06 m	10 ft 0 in	3,06 m	10 ft 0 in
Maximum outreach above the ground	2,58 m	8 ft 6 in	2,58 m	8 ft 6 in
Maximum jib articulation point height	6,20 m	20 ft 4 in	6,83 m	22 ft 5 in
Turret rotation	345 °			
Jib working range	130°			
Total weight	2600kg	5733 lb	2680 kg	5909 lb
Maximum platform capacity	200 kg	441 lb	200 kg	441 lb
Maximum number of occupants allowed	Indoor use : 2 Outdoor use : 2		Indoor use : 2 Outdoor use : 1	
Maximum wind speed allowed	45 km/h	28 mph	45 km/h	28 mph
Manual force - CE - AS	Indoor use : 400 N (90 lbf) Outdoor use : 400 N (90 lbf)		Indoor use : 400 N (90 lbf) Outdoor use : 200 N (45 lbf)	
Gradeability - 2WD	25 %			
Maximum rated slope allowed - CE - AS	3°			
Maximum load on wheel	1346 kg	3185 lbf	1370 kg	3550 lbf
Maximum ground pressure of wheel on paved ground	13,9 daN/cm ²	224 psi	16,8 daN/cm ²	238 psi
Drive speed :				
• Folded machine maximum speed - High speed	5 km/h	3.1 mph	5 km/h	3.1 mph
• Unfolded machine maximum speed - Micro-speed	0,6 km/h	0.4 mph	0,6 km/h	0.4 mph
Maximum freewheel speed during towed operation	5 km/h	3.1 mph	5 km/h	3.1 mph
Outside turning radius	1,88 m	6 ft 2 in	1,88 m	6 ft 2 in
Inside turning radius	0,45 m	1 ft 6 in	0,45 m	1 ft 6 in
Solid tires/tyres	406 mm x 100 mm (16 in / 4 in)			
Power source				
Electric motor	AC - 2,17 kW / 2.9 hp			
Specifications - Performance				
Operating temperature	- 20° C / + 40° C (- 68° F / + 104° F)			
Storage temperature	- 10° C / + 40° C (- 50° F / + 104° F)			
Energy storage				
Type of battery	Traction			
System voltage	24 V			
Battery capacity	250 Ah			
Hydraulic tank capacity	7 L	2 gal US	7 L	2 gal US

B - Familiarization

ANSI and CSA standards

Machine	STAR 22J		STAR 26J	
Characteristics - Dimensions	SI	Imp.	SI	Imp.
Maximum working height	8,75 m	28 ft 9 in	9,95 m	32 ft 8 in
Maximum platform height	6,75 m	22 ft 1 in	7,95 m	26 ft 1 in
Maximum horizontal reach	3,06 m	10 ft 0 in	3,06 m	10 ft 0 in
Maximum outreach above the ground	2,58 m	8 ft 6 in	2,58 m	8 ft 6 in
Maximum jib articulation point height	6,20 m	20 ft 4 in	6,83 m	22 ft 5 in
Turret rotation	345 °			
Jib working range	130°			
Total weight	2835 kg	6251 lb	2900 kg	6395 lb
Maximum platform capacity	227 kg	500 lb	227 kg	500 lb
Maximum number of occupants allowed	Indoor use : 2 Outdoor use : 2		Indoor use : 2 Outdoor use : 2	
Maximum wind speed allowed	45 km/h	28 mph	45 km/h	28 mph
Manual force - ANSI - CSA	666 N - 150 lbf			
Gradeability - 2WD	25 %			
Maximum rated slope allowed - ANSI - CSA	0°			
Maximum load on wheel	1445 kg	3185 lbf	2270 kg	3550 lbf
Maximum ground pressure of wheel on paved ground	15,46 daN/cm ²	224 psi	16,44 daN/cm ²	238 psi
Drive speed :				
• Folded machine maximum speed - High speed	5 km/h	3.1 mph	5 km/h	3.1 mph
• Unfolded machine maximum speed - Micro-speed	0,6 km/h	0.4 mph	0,6 km/h	0.4 mph
Maximum freewheel speed during towed operation	5 km/h	3.1 mph	5 km/h	3.1 mph
Outside turning radius	1,88 m	6 ft 2 in	1,88 m	6 ft 2 in
Inside turning radius	0,45 m	1 ft 6 in	0,45 m	1 ft 6 in
Solid tires/tyres	406 mm x 100 mm (16 in / 4in)			
Power source				
Electric motor	AC - 2,17 kW / 2.9 hp			
Specifications - Performance				
Operating temperature	- 20° C / + 40° C (- 68° F / + 104° F)			
Storage temperature	- 10° C / + 40° C (- 50° F / + 104° F)			
Energy storage				
Type of battery	Traction			
System voltage	24 V			
Battery capacity	250 Ah			
Hydraulic tank capacity	7 L	2 gal US	7 L	2 gal US

B - Familiarization

4.2 - WORKING AREA / RANGE OF MOTION

STAR 8 - STAR 22J - STAR 10 - STAR 26J

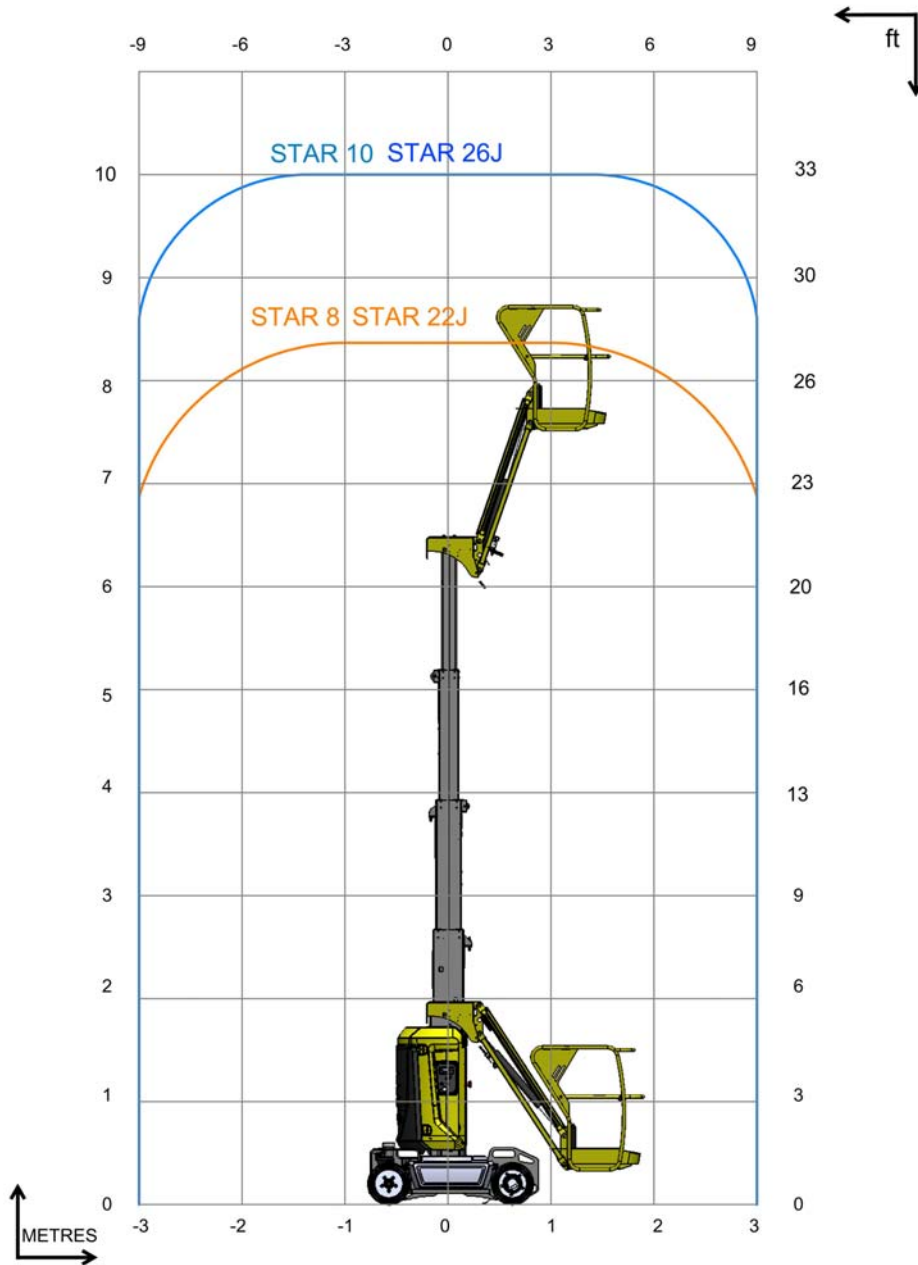

A

B

C

D

E

F

G

H

I

B - Familiarization

5 - Decals and markings locations

CE and AS standards - STAR 8 - STAR 10 — 1/2

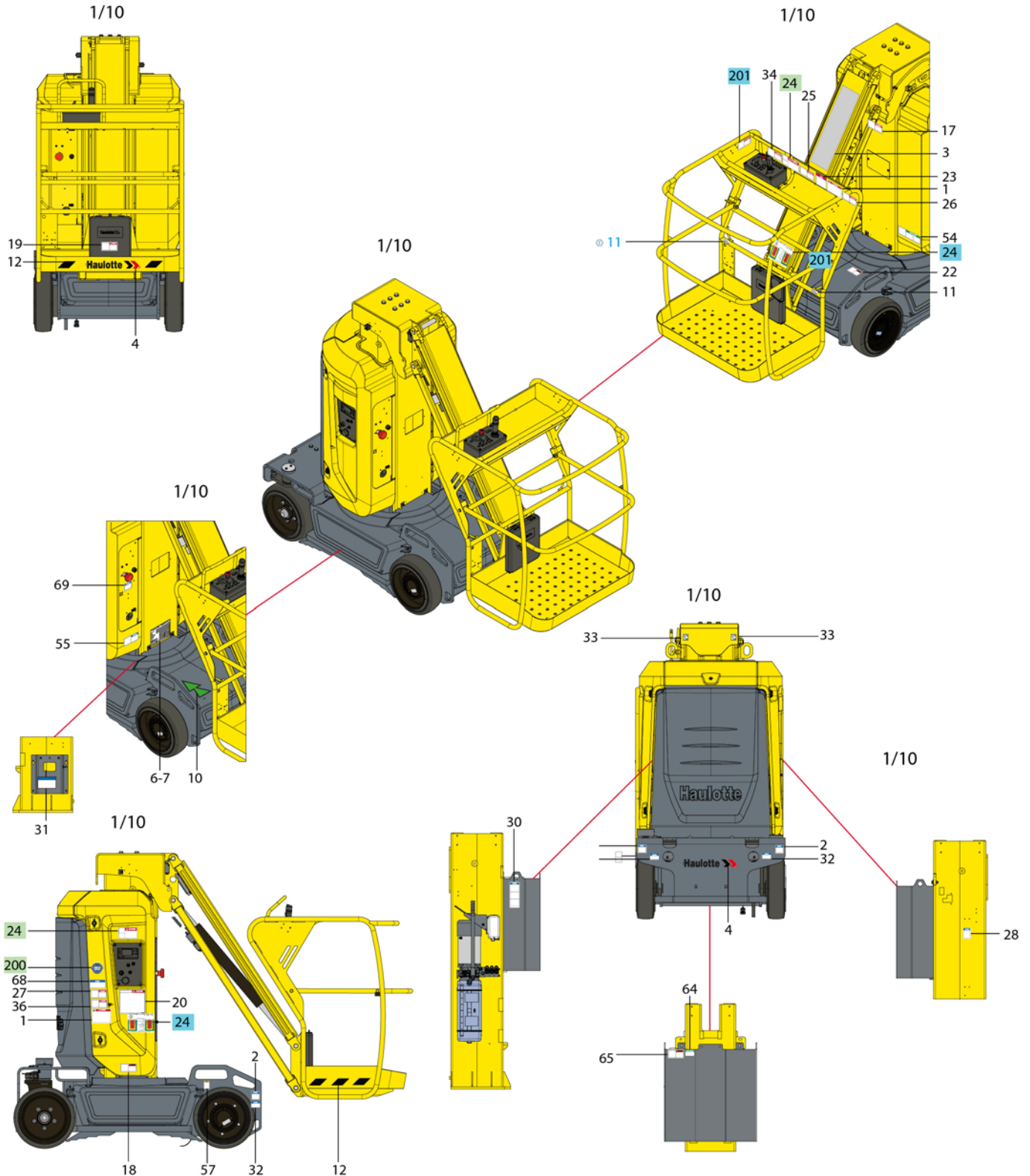

B - Familiarization

CE and AS standards - STAR 8 - STAR 10 — 2/2

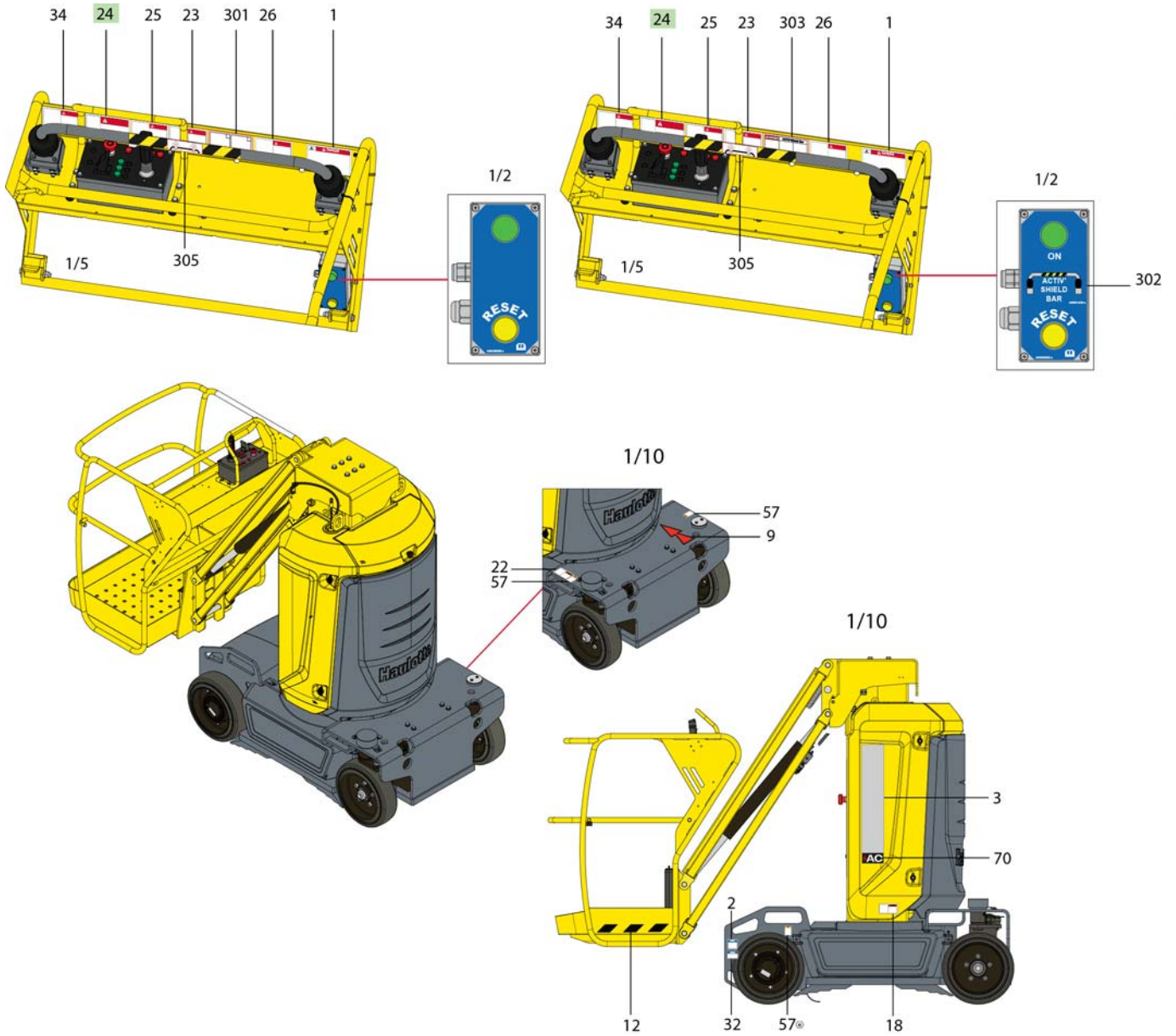

A
B
C
D
E
F
G
H
I

B - Familiarization

CE and AS standards

Marking	Color	Description	Quantity	STAR 8	STAR 10
1	Red	Height of the floor and load	2	4000420030	4000419940
2	Blue	Maximum Pressure per Tire - Floor Loading	4	4000325390	4000318050
3	Other	Commercial name	2	307P217430	4000358900
4	Other	Decal HAULOTTE® - 500 x 100 - Bright machine	2	307P218180	
4	Other	Decal HAULOTTE® - 500 x 100 - Dark machine	2	307P224740	
4	Other	Decal HAULOTTE® - 500 x 100 - Red machine	2	307P220360	
6	Other	Identification plate	1	3078146180	
9	Other	Control of movements - RED directional arrow	1	3078148830	
10	Other	Control of movements - GREEN directional arrow	1	3078148820	
11	Other	Lanyard attachment points	2	307P216290	
12	Other	Material risk - Yellow and black adhesive tape	1	2421808660	
16	Other	Max and min oil level	1	307P221060	
17	Red	Risk of crushing	1	4000272910	
18	Orange	Hand crushing hazard - Risk of crushed hands	2	4000024890	
19	Red	Operation instructions	1	4000025140	
20	Red	Operation instructions	1	In german (CE standard) : 307P222730 In english (CE and AS standards) : 307P222740 In chinese (CE standard) : 4000698920 In korean (CE and AS standards) : 4000618590 In croatian (CE standard) : 4000360810 In danish (CE standard) : 307P222760 In spanish (CE standard) : 307P222770 In estonian (CE standard) : 4000360870 In finnish (CE standard) : 307P222780 In french (CE standard) : 3078149030 In greek (CE standard) : 4000561810 In dutch (CE standard) : 307P222790 In hungarian (CE standard) : 4000360890 In italian (CE standard) : 307P222800 In japanese (CE standard) : 4000359830 In latvian (CE standard) : 4000359840 In lithuanian (CE standard) : 4000359850 In norwegian (CE standard) : 4000359900 In polish (CE standard) : 4000359860 In portuguese (CE standard) : 307P222810 In romanian (CE standard) : 4000359870 In slovakian (CE standard) : 4000359880 In slovenian (CE standard) : 4000359890 In swedish (CE standard) : 307P222820	
22	Orange	Wound foot - Do not place foot	2	4000027090	
23	Red	Risk of crushing - Driving direction	1	4000273080	
24	Red	Danger of electrocution	2	For CE standard only : 4000273930 For AS standard only : 4000227500	
25	Red	Risk of crushing - Closing drop rail	1	4000025080	
26	Red	Danger of electrocution - Ground for welding	1	4000027100	

B - Familiarization

Marking	Color	Description	Quantity	STAR 8	STAR 10
27	Red	Verification of tilt operation	1	4000272920	
28	Red	Do not interchange	1	4000504670	
30	Blue	Hand pump	1	307P227170	
31	Blue	Brake release	1	4000361570	
32	Blue	Anchorage point - Traction	4	4000027310	
33	Blue	Anchorage point - Elevation	2	4000027330	
34	Red	Risk of electrocution - Water projection	1	4000025130	
36	Red	Risk of crushing - Platform	1	4000318140	
54	Green	Emergency jib and mast lowering	1	4000274030	
55	Yellow	Risk of electrocution - Charger - 240 V	1	For CE standard only : 4000273940 For AS standard only : 4000307410	
57	Orange	Position of the lift truck forks	4	3078143830	
64	Green	Battery verification	1	4000274040	
65	Orange	Hand crushing hazard - Battery	1	4000027440	
68	Blue	Transport height	1	4000417450	
69	Blue	Battery isolation switch	1	4000420660	
70	Other	Decal AC	1	4000425350	
72	Other	Demineralized Water	1	4000668080	
200	Other	"Made in Europe"	1	For CE standard only : 4000137690	
201	Red	Wearing of a safety harness is essential	1	For AS standard only : 4000275670	
Not illustrated	Not illustrated	Option — Working area / Range of motion	1	4000361810	4000361820

A

B

C

D

E

F

G

H

I

B - Familiarization

EAC standard - STAR 8 - STAR 10 — 2/2

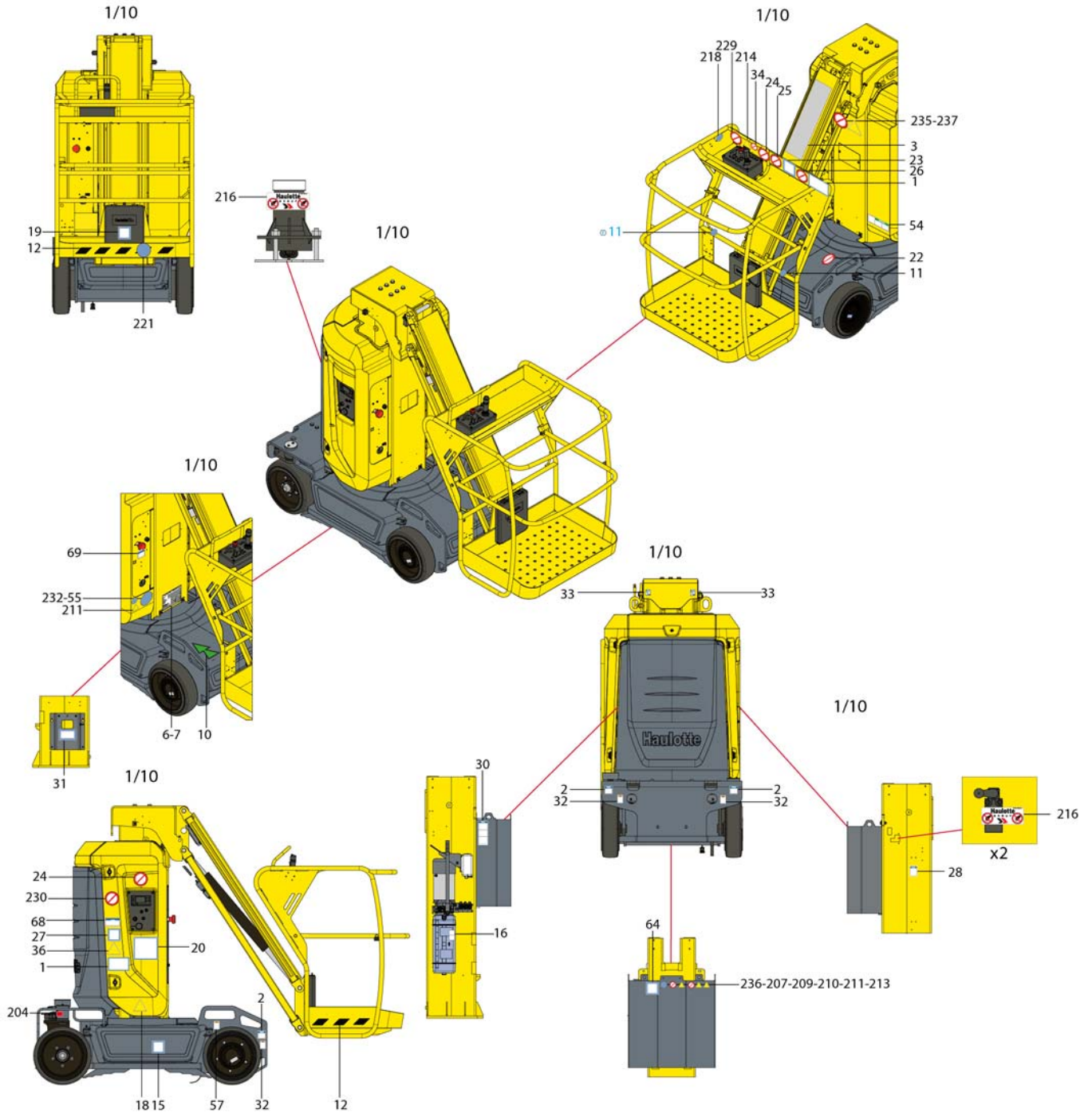

B - Familiarization

EAC standard - STAR 8 - STAR 10 — 2/2

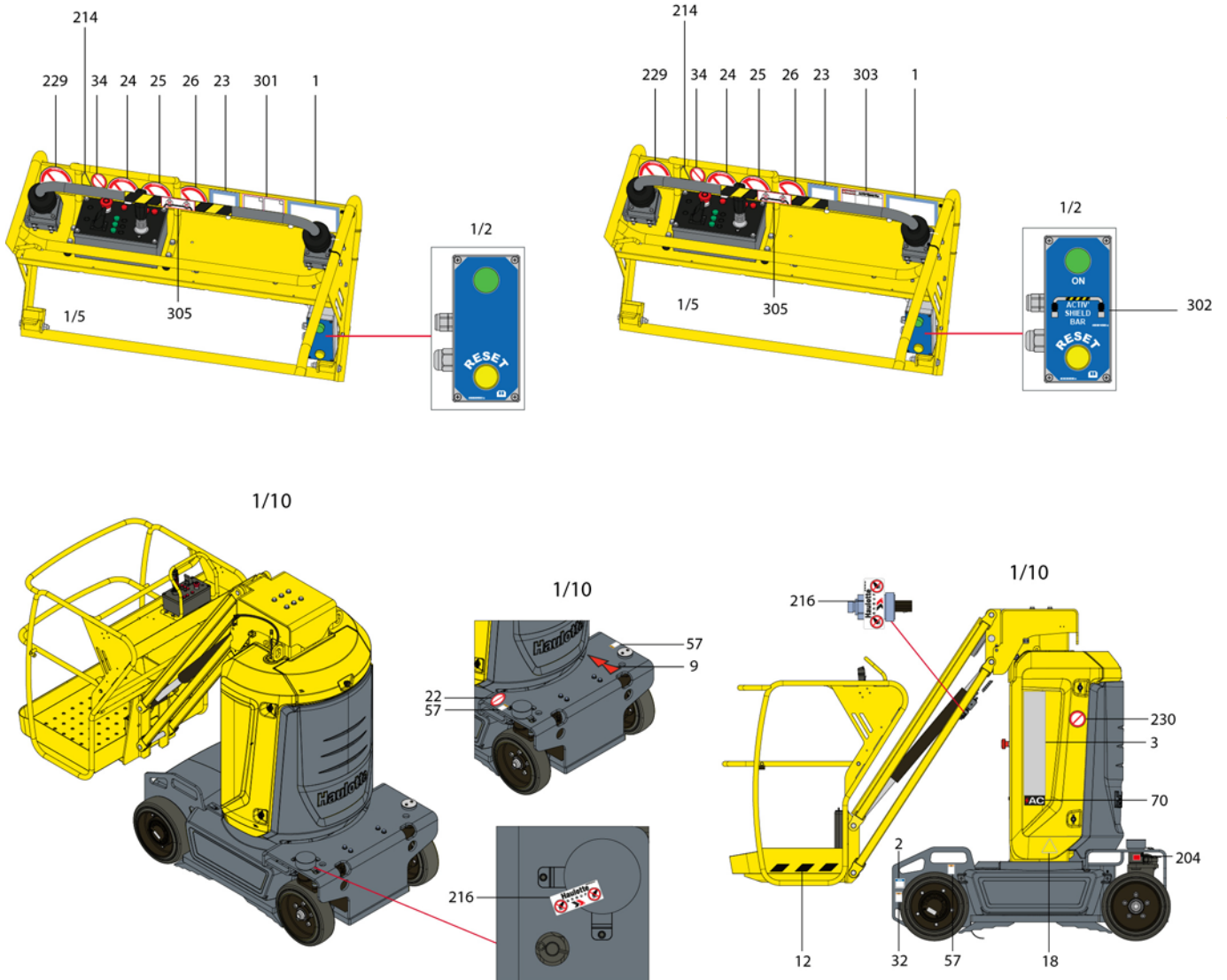

B - Familiarization

EAC standard

Marking	Color	Description	Quantity	STAR 8	STAR 10
1	Red	Height of the floor and load	2	4000420040	4000419990
2	Blue	Maximum Pressure per Tire - Floor Loading	4	4000325390	4000318050
3	Other	Commercial name	2	307P217430	4000358900
6	Other	Identification plate	1	For Russia : 4000388680 For Ukraine : 4000054150	
9	Other	Control of movements - RED directional arrow	1	3078148830	
10	Other	Control of movements - GREEN directional arrow	1	3078148820	
11	Other	Lanyard attachment points	2	307P226710	
12	Other	Material risk - Yellow and black adhesive tape	1	2421808660	
15	Blue	Greasing the turntable rotation gear	1	307P227020	
16	Other	Max and min oil level	1	307P221060	
18	Orange	Hand crushing hazard - Risk of crushed hands	2	307P227660	
19	Red	Operation instructions	1	For Russia : 307P227190 For Ukraine : 307P227840	
20	Blue	Operation instructions	1	For Russia : 4000359920 For Ukraine : 4000359910	
22	Orange	Wound foot - Do not place foot	2	307P227010	
23	Red	Risk of crushing - Driving direction	1	307P227040	
24	Red	Danger of electrocution	2	307P226960	
25	Red	Risk of crushing - Closing drop rail	1	307P226950	
26	Red	Danger of electrocution - Ground for welding	1	307P226970	
27	Red	Verification of tilt operation	1	For Russia : 307P227060 For Ukraine : 307P227870	
28	Red	Do not interchange	1	4000504670	
30	Blue	Hand pump	1	307P227170	
31	Blue	Brake release	1	4000361720	
32	Blue	Anchorage point - Traction	4	4000135970	
33	Blue	Anchorage point - Elevation	2	4000135960	
34	Red	Risk of electrocution - Water projection	1	307P226780	
36	Red	Risk of crushing - Platform	1	4000014290	
54	Green	Emergency jib and mast lowering	1	4000013910	
55	Yellow	Risk of electrocution - Charger - 240 V	1	307P227520	
57	Orange	Position of the lift truck forks	4	4000013830	
64	Green	Battery verification	1	For Russia : 307P227180 For Ukraine : 307P227860	
68	Blue	Transport height	1	4000417450	
69	Blue	Battery isolation switch	1	4000420660	
70	Other	Decal AC	1	4000425350	
72	Other	Demineralized Water	1	4000668080	
204	Red	Lubrication point	2	307P219370	
207	Red	Smoking forbidden	1	307P226760	
209	Yellow	Battery danger	1	307P226790	
210	Yellow	Fire Hazard	1	307P226800	
211	Yellow	Electrical danger	2	307P226810	
213	Yellow	Corrosion hazard	1	307P226830	
214	Yellow	Danger unstable side	1	307P226930	
216	Other	Tamper-proof	5	307P227450	

B - Familiarization

Marking	Color	Description	Quantity	STAR 8	STAR 10
218	Blue	Caution helmet compulsory	1	307P226680	
221	Blue	Obligatory routing	1	307P227510	
229	Red	Do not travel down slopes in high speed	1	307P226990	
230	Red	No admittance to unauthorized persons	2	307P227560	
232	Blue	Electric socket 24V	1	307P226740	
235	Yellow	Vertical crushing of the body	1	4000014270	
236	Blue	Caution glasses	1	307P226670	
237	Yellow	Risk of crushing	1	307P227670	
Not illustrated	Not illustrated	Option — Working area / Range of motion	1	4000361810	4000361820

A

B

C

D

E

F

G

H

I

B - Familiarization

ANSI and CSA standards - STAR 22J - STAR 26J — 1/2

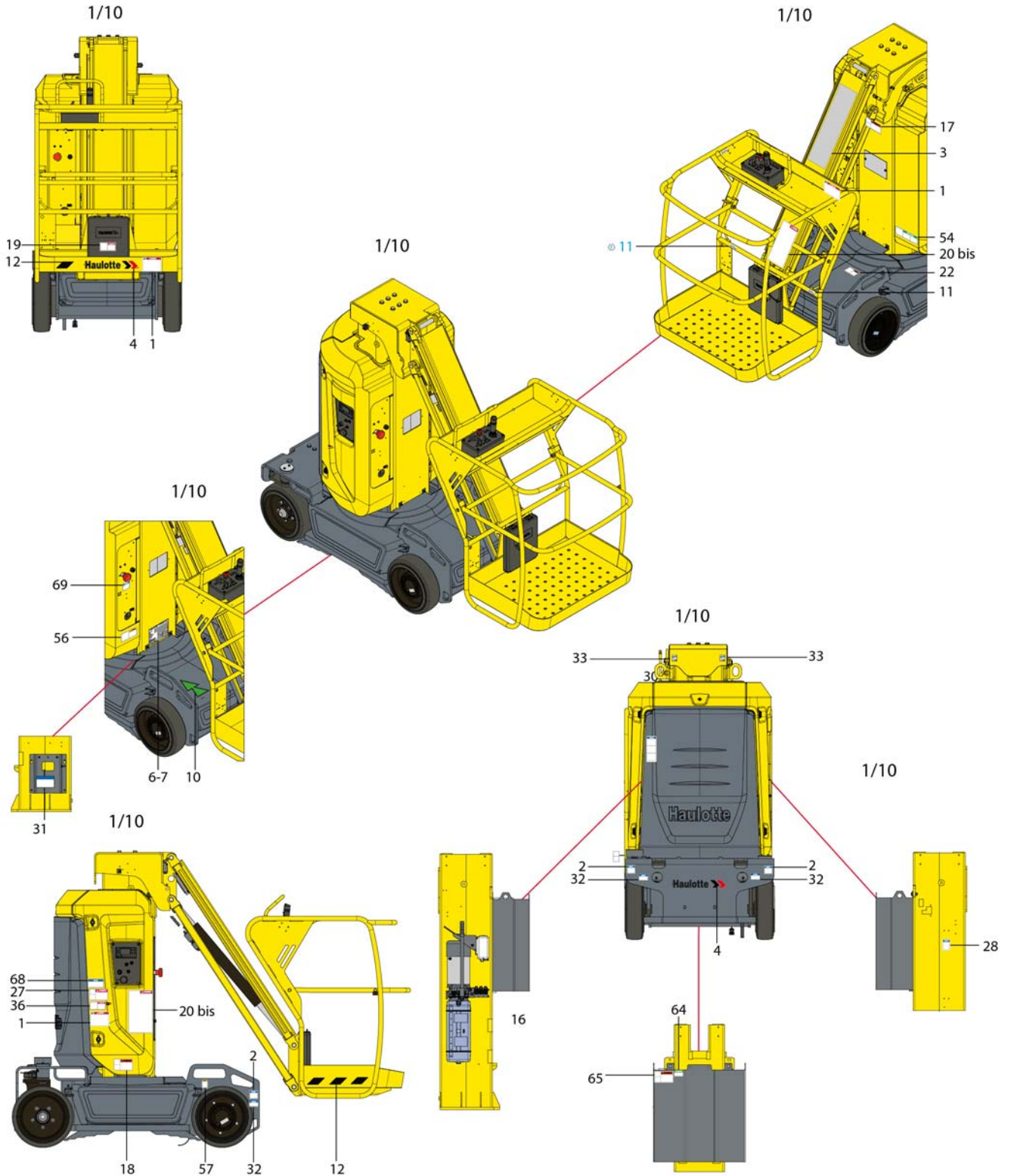

B - Familiarization

ANSI and CSA standards - STAR 22J - STAR 26J — 2/2

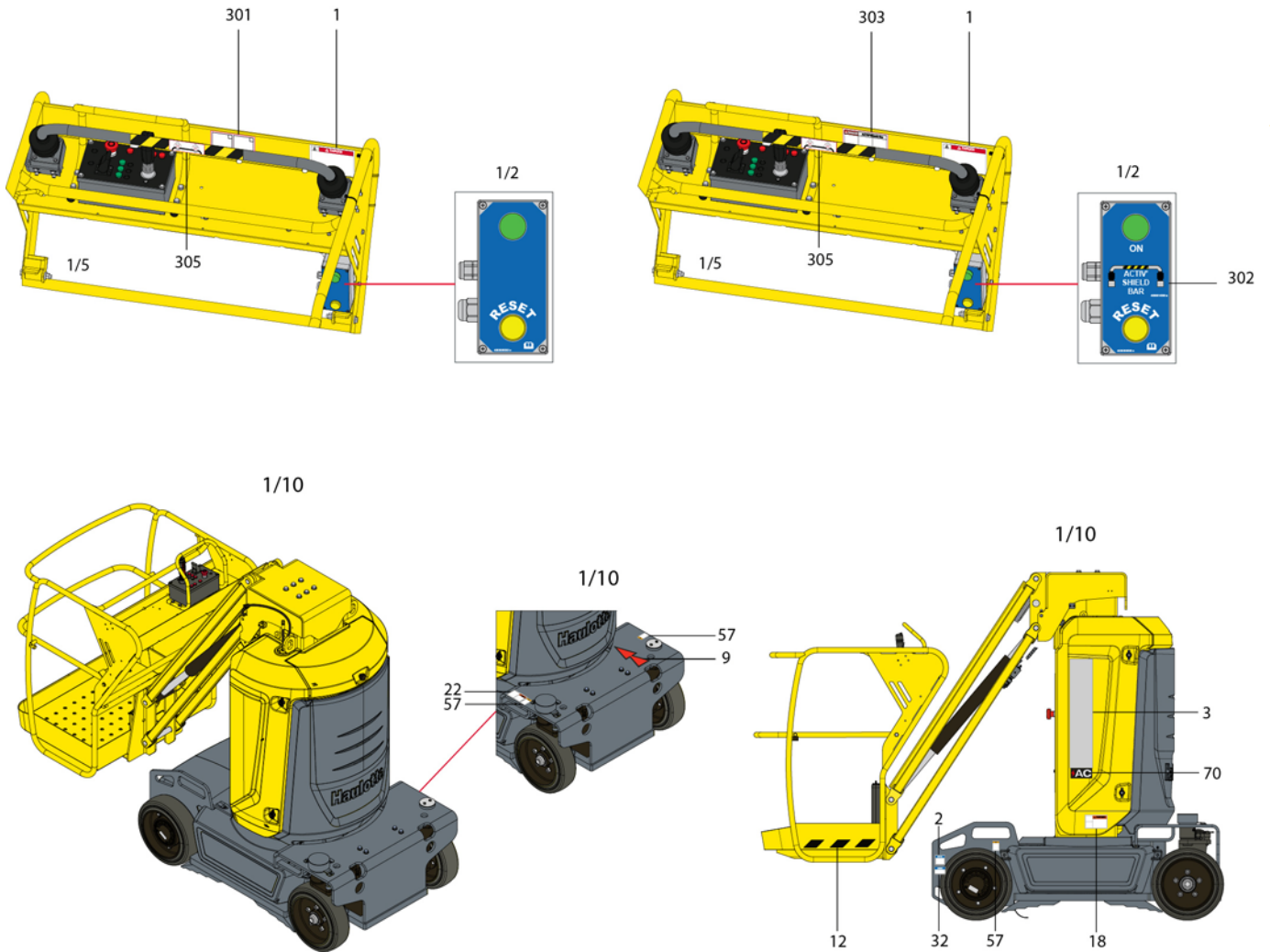

A

B

C

D

E

F

G

H

I

B - Familiarization

ANSI and CSA standards

Marking	Color	Description	Quantity	STAR 22J	STAR 26J
1	Red	Height of the floor and load	3	In english : 4000420060 In french : 4000420070 In spanish : 4000420080	In english : 4000420000 In french : 4000420010 In spanish : 4000420020
2	Blue	Maximum Pressure per Tire - Floor Loading	4	4000325400	4000325410
3	Other	Commercial name	2	4000418330	4000418360
4	Other	Decal HAULOTTE® - 500 x 100 - Bright machine	2	307P218180	
4	Other	Decal HAULOTTE® - 500 x 100 - Dark machine	2	307P224740	
4	Other	Decal HAULOTTE® - 500 x 100 - Red machine	2	307P220360	
6	Other	Identification plate	1	307P218930	
9	Other	Control of movements - RED directional arrow	1	3078148830	
10	Other	Control of movements - GREEN directional arrow	1	3078148820	
11	Other	Lanyard attachment points	2	307P216290	
12	Other	Material risk - Yellow and black adhesive tape	1	2421808660	
16	Other	Max and min oil level	1	307P221060	
17	Red	Risk of crushing	1	In english : 4000275590 In french : 4000275600 In spanish : 4000275610	
18	Orange	Hand crushing hazard - Risk of crushed hands	2	In english : 4000024770 In french : 4000067710 In spanish : 4000086490	
19	Red	Operation instructions	1	4000025140	
20bis	Red	Operation instructions	2	In english : 4000326910 In french : 4000326310 In spanish : 4000326900	
22	Orange	Wound foot - Do not place foot	2	In english : 4000024840 In french : 4000068180 In spanish : 4000086610	
27	Red	Verification of tilt operation	1	In english : 4000275480 In french : 4000275490 In spanish : 4000275500	
28	Red	Do not interchange	1	4000504670	
30	Blue	Hand pump	1	307P227170	
31	Blue	Brake release	1	4000361570	
32	Blue	Anchorage point - Traction	4	4000027310	
33	Blue	Anchorage point - Elevation	2	4000027330	
36	Red	Risk of crushing - Platform	1	4000318140	
54	Green	Emergency jib and mast lowering	1	4000274030	
56	Blue	Socket - 110 V	1	4000419150	
57	Orange	Position of the lift truck forks	4	3078143830	
64	Green	Battery verification	1	4000274040	
65	Orange	Hand crushing hazard - Battery	1	In english : 4000025030 In french : 4000068120 In spanish : 4000086550	
68	Blue	Transport height	1	4000417450	

B - Familiarization

Marking	Color	Description	Quantity	STAR 22J	STAR 26J
69	Blue	Battery isolation switch	1	4000420660	
70	Other	Decal AC	1	4000425350	
72	Other	Demineralized Water	1	4000668080	
Not illustrated	Not illustrated	Option — Working area / Range of motion	1	4000361810	4000361820

A

B

C

D

E

F

G

H

I

B - Familiarization



Notes

C - Pre-operation inspection

1 - Recommendations

The owner, the site manager, the supervisor and the operator are all responsible to ensure the machine is fit for the work it is to perform; i.e. that the machine is suitable to carry out the work in complete safety and in compliance with this Operator's Manual. All managers who are responsible for persons operating the machine must be familiar with the local regulations currently applicable in the country of use and ensure that they are adhered to.

Before using the machine, read the previous chapters in this manual. Ensure that you have understood the following points :

- Safety precautions.
- Operator's responsibilities.
- Conditions and the operating principles of the machine.

A

B

C

D

E

F

G

H

I

C

- Pre-operation inspection

2 - Working area assessment

To ensure safety during operation, the following should be considered :

- Segregate other site traffic (delivery vehicles, dumpers, etc) from the work area.
- Check the work area for localized features, e.g. manholes, service ducts, potholes, etc.
- Check ground covers (temporary and permanent) are strong enough to withstand the applied pressure.
- Check ground covers are secured and monitor them. Take similar action for permanent covers.
- Check the load bearing capacity (distributed load and point loading, e.g. outriggers) when working inside a building, or on a structure.
- Check the load bearing capacity (distributed load and point loading, e.g. outriggers) of the supporting ground.
- Provide supervision to ensure safe systems of work are appropriate and being used.
- Check for overhead crushing and contact hazards.
- Check weather conditions have not altered ground conditions (e.g. heavy or prolonged rain).
- Establish limits for safe operation (e.g. maximum wind speed). Remember conditions can change internally (e.g. if roller doors are opened).
- Comply with permit to work systems where sites have them (e.g. chemical plants).
- Provide a rescue plan for all risks, including falls and crush hazards. Ensure personnel understand and are appropriately trained in the rescuing procedures. Site based personnel trained in operation of functions and in the emergency lowering systems from the ground control box should be present. Ensure that access to the ground controls is available.
- Assess other alternative work methods or equipment before operating near a steep slope. If the machine must be placed near an edge or steep slope, ensure barriers are available to support the weight of the machine. Take into consideration the machine's stopping distance. If this is not possible, evaluate and establish the placement of machine and sequence of operations so that the aerial work platform can operate in a safe manner (e.g. machine is in line with the edge rather than towards the edge).

Extra care must be taken if aerial work platforms are used to manoeuvre up through several levels of steelwork. There is a risk of the operator being trapped should the basket strike the steelwork.

This risk increases with the number of steelwork levels and if material is piled up on lower level reducing the spacing between levels.

C - Pre-operation inspection

3 - Inspection and Functional test

3.1 - DAILY INSPECTION

Each day before the beginning of a new work session and with each change of operator, the machine must be subjected to a visual inspection and a complete functional test.



- Never use a defective or a malfunctioning aerial work platform.
- If any item on the check list is marked "No" during the inspection; machine must be tagged and placed out of service.
- Do not operate the machine until all identified items are corrected and it has been declared safe for operation.

In case of loose fasteners, refer to torque table value in maintenance book.

In case of leaks, replace the damaged part before use.

In case of structural part deformation, cracks, broken weld, paint chips, replace the part before use.

Sample of broken welds

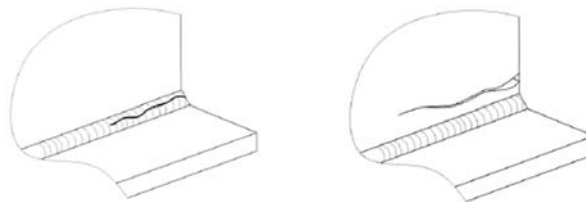

Inspection Forms are provided to assist your inspection process.

We recommend these forms to be completed daily and stored to assist with your maintenance schedule.









Each action is depicted in the daily inspection sheet using the following symbols.

	Visual inspection without disassembly		Lubrication-Grease		Functional adjustments
	Drain		Test and validate		Tighten
	Check levels		Systematic replacement		
	Visual inspection with small disassembly or movement needed to reach the part. Replacement is necessary.		Proof tests. Need HAULOTTE Services® authorization. For countries where machines are not subject to controlled periodic maintenance.		

C - Pre-operation inspection

		Daily inspection			
	Visual inspection without disassembly		Check level		
			To check by test		
		Yes	No	Corrected	Not applicable
Manuals and displays. Clean or replace if necessary.					
	Presence, cleanliness and legibility of the manufacturer's plate				
	Presence, cleanliness and legibility of operator's and maintenance manuals				
	Presence and cleanliness of load chart of the machine				
Control box (Ground and Platform)					
	Presence and cleanliness of the control box				
	No visible damage				
	All decals at the control boxes are clean and legible				
	Operation of start / stop device				
	Operation of E-stop button device				
	Operation of enable switch				
	Operation of horn from platform control box				
	Operation of movement from platform control box				
	Test warning alarm lights and buzzer				
	Overriding indicators turn off after 1 sec				
	No abnormal noise and jerky movements from platform control box				
	Joysticks and movement switches return to neutral				
Work Platform. Floor, guardrails, access and extensions					
	Absence of cracks, broken parts, damaged paint				
	No deterioration and visible damage				
	Harness anchor points are not cracked or damaged, with the decal attached and legible				
	No screws missing / loose parts				
	Entry bar/gate closes automatically and is not prevented from closing.				
	Folding guard-rail (if fitted) is fixed securely in position				
Extending structure (jib, mast)					

C - Pre-operation inspection

Absence of cracks, broken parts, damaged paint					
No deterioration and visible damage					
No screws missing / loose parts					
No foreign body in joints or slides					
Presence of securely fitted maintenance devices (safety stand)					
All compartments covers open and lock properly					
Frame, axle, steering system, stabilizers arms ...					
Absence of cracks, broken parts, damaged paint					
No deterioration and visible damage					
No screws missing / loose parts					
No foreign body in joints or slides					
Condition of tires/tyres (wear, cutting, damage ...)					
Wheel reducer is undamaged and operates smoothly					
All compartments covers open and lock properly					
Rotation system : orientation turret, basket and jib					
Absence of cracks, broken parts, damaged paint					
No deterioration and visible damage					
No screws missing / loose parts					
No foreign body in joints or slides					
Exterior gear wheel greasing					
Pin, pin stop, bearing ...					
Presence of the turret pin and its locking device					
No bent, cracked or broken pins, pin stops, bushes or bearings					
Pulleys, chains and wire rope					
No cracked or broken chains, links and fittings					
Pulleys and clamps are not worn, rusted or damaged					
Cylinder and hydraulic component : pumps, filters, manifold					
No leaks on the pump, tank or fittings					
No deformation, visible damage, broken weld or leaks on hydraulic cylinder					
No screws missing / loose parts					
Check hydraulic oil level is above the minimum level (Machine folded)					
Energy storage and motorisation: tanks, batteries and engine					

A

B

C

D

E

F

G

H

I

C - Pre-operation inspection

Battery electrolyte level					
Level of centralized battery refilling					
No screws missing / loose parts					
Presence and good condition of hydraulic hose					
Presence and good condition of engine components					
Presence and good condition of the batteries: terminations and clamps, electrolyte level ...					
Electric cables					
No torn or split wire sheaths					
No evidence of chemical damage or corrosion on all cables					
No oxidation or corrosion on terminals					
Sensors and safety device					
Activation of Activ'Shield Bar					
Slope limiting device operates properly					
Test of load sensing system (visual warning at control box)					
Serial number : Hours of operation : HAULOTTE Services® contract reference : Intervention record number : Date : Name :		Model :			
		Signature :			

C - Pre-operation inspection

4 - Safety functional checks

To protect the user and the machine, safety systems prevent the movement of the machine beyond its operating limits. These safety systems when activated immobilize the machine and prevent further movement.

The operator must be familiar with this technology and understand that is not a malfunction but an indication that the machine has reached an operation limit.

Aerial Work platforms are equipped with two control boxes which allow operators to safely use the machine. An auxiliary device (overriding system) is available on ground control box when primary power source fails. Each control box is equipped with an E-Stop button, which cuts all movements when pushed in.

The following checks describe the operation of the machine and the specific controls required.

For the location and description of these controls :  refer to section B 3.2 and D 2 Ground control box and B 3.3 and D 3 Platform control box.

4.1 - E-STOP BUTTON CHECK

Ground control box E-stop button

Step	Action
1	Pull the E-stop buttons (15, 46).
2	Turn the control box activation selector key (92) downwards to activate the ground control box.
3	The screen turns on.
4	Push the E-stop button (15). The screen turns off.

Platform control box E-stop button

Step	Action
1	Pull the E-stop buttons (15, 46).
2	Turn the control box activation selector key (92) upwards to activate the platform control box.
3	The screen turns on.
4	Push the E-stop button (46). The display panel goes blank.

C - Pre-operation inspection

4.2 - ACTIVATION OF CONTROLS

The enable switch must be activated to allow any movement.

The "Enable Switch" system depends on the machine configuration and will consist of one of the following :

- Joystick trigger at platform box (if fitted).
- Foot pedal (enable switch) in the platform.
- Enable switch at ground and platform boxes.

4.3 - FAULT DETECTOR

The machine is equipped with an on-board fault detection system, which indicates the type of fault to the operator.

The fault is identified by a default code.

The default code is displayed at the ground control box.

According to the type of fault, the machine MAY switch into DOWNGRADEMODE mode and certain movements are prevented to maintain Operator's safety.

Do not use the machine until the fault has been corrected.

4.3.1 - Buzzers test

From the ground control box

Step	Action
1	Pull both the E-Stop buttons (46) at platform box and (15) at ground box.
2	Turn the control box activation selector key (92) downwards or upwards to activate a control box.
3	An audible signal (beep) sounds.

4.4 - OVERLOAD SENSING SYSTEM (IF FITTED)

If the platform load exceeds the maximum allowed load, no movement is possible from the 2 control boxes.

At ground and platform control boxes a buzzer sounds and an indicator light warns the operator.

To return the machine to normal operation remove weight from the platform until the load is below the maximum allowed load.

Daily check that the LED's illuminate when the machine is switched on :

- Verify that the Overload system is active : Refer to Indicators (6) at ground and (30) at platform.
- Verify that the buzzers are functioning : Refer to Buzzers test

A periodic inspection of this device must be performed according to the recommendation in Maintenance Schedule.

C - Pre-operation inspection

4.5 - SLOPE WARNING DEVICE

From each control box, a buzzer alerts the operator that the machine is not folded/stowed and is positioned on a slope exceeding the slope allowed.

N.B.-:The slope sensor is only active when the platform is not in the stowed position.

When machine is on a slope greater than the rated slope, with extending structure out of the stowed position, DRIVE function is disabled(For CE, AS and CSA only).

All functions speeds are reduced.

In this case, fully retract the mast and reposition the machine on level ground before extending the mast again.

To restore the drive function, perform the function movements in the following sequence :

1. Lower the mast.
2. Lower the jib.
3. Rotate the turntable.

To check the tilt sensor at ground control box

Step	Action
1	Pull both E-Stop buttons (15) at ground box and (46) at platform box.
2	Turn the control box activation selector key (92) downwards to activate the ground control box.
3	Raise the telescoping mast upto 1 m(3 ft3 in).
4	Open the compartment cover on the ground control box side ( Machine components diagram) to locate tilt sensor (C64).
5	Tilt sensor is located on the base plate of turret on the right hand side of the ground control box.
6	Manually tilt and maintain the tilt sensor towards the front for a few seconds.
7	The audible beep sounds.
8	For machines fitted with : The slope sensor prevents lifting and driving movements

4.6 - TRAVEL SPEED LIMITATION

All driving speeds are allowed when the mast is retracted, whatever the jib position.

The only speed allowed when not in stowed position is microspeed (This speed is a default speed programed into the machine).



Risk of overturning

Driving at high speed with jib above horizontal position increases the risk of overturning. Perform imperatively this movement on a stable, flat and clear surface to support the weight of the lift.

4.7 - ELECTRONIC VARIABLE SPEED DRIVE

The machine is equipped with 2 electronic variable speed regulators configured for each function that manages the amount of power sent to each motor.



Do not interchange the speed controllers/regulators between machines even if they are the same model..

C - Pre-operation inspection

4.8 - MACHINE BRAKING

When electric power is cut off, the machine stops automatically.

Performance levels may be reduced in the following situations :

- Descending a bumpy ramp.
- Worn tires/tyres.
- Damp or muddy ground conditions.

Check that the brakes are applied automatically when the Drive joystick is released to the neutral position.

4.9 - POTHOLE PROTECTION SYSTEM

The chassis is constructed with stationary structural members on the sides, serving as pot hole protection (anti-tipping) device.

4.10 - ON-BOARD CHARGER

Battery charging starts as soon as an external supply is connected to the battery charger.



When the battery pack is being charged with an external power supply, the machine's electric system is automatically deactivated.

4.10.1 - Battery charge level

The indicator (90) located by the side of ground control box indicates battery charge status :

- Green indicator : Battery charged 100 %.
- Yellow indicator : Battery charged 80 %.
- Red indicator : Battery in initial charging phase.

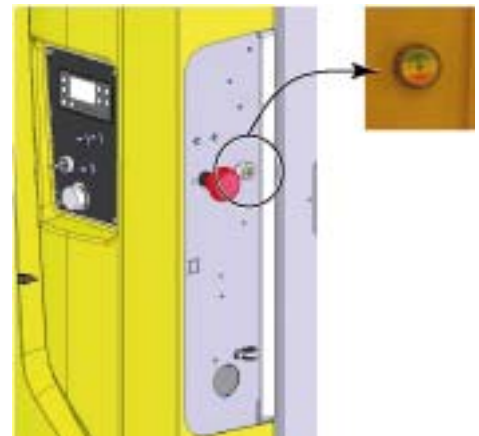

D - Operation instructions

1 - Operation

1.1 - INTRODUCTION

Aerial Work platforms are equipped with two control boxes which allow operators to safely use the machine.

An auxiliary device is available at the ground control box to assist in the rescue of people in an emergency.

Each control box is equipped with an E-Stop button, which allows operators to stop all movements, if necessary.

Only trained and authorized personnel shall be permitted to operate this aerial work platform.

Prior to operation :

- Read, understand and obey all instructions and safety precautions in this manual and attached to the aerial work platform.
- Read, understand and obey all Federal, State and local codes and regulations.
- Become familiar with the proper use of all controls and emergency systems.

1.2 - OPERATION FROM A CONTROL BOX

The control box is energized and active ONLY when :

- The E-stop buttons are released.
- The control box is selected.

The enable switch (228) on the ground control box must be activated and held to authorise movements. If the enable switch is held for 8 seconds without selecting a function, then it is automatically deactivated

The release of the enable switch during operation stops all movements. If the enable switch is pressed again, the movement does not restart. The joystick/functions switch must be released to neutral before movements can re-start.

All switches and joysticks return automatically to the neutral position when released.

The status of switches, indicators and joysticks are tested automatically when the machine is switched on. A switch or joystick will be active only after it has been detected in the neutral position.

A buzzer beeps in the following configurations :

- When power is switched on.
- Overload (if fitted).
- Slope limits exceeded (if machine is out of stowed position).

D - Operation instructions

2 - Ground control box

2.1 - TO START AND STOP THE MACHINE



- Pull the E-Stop button at the ground control box.
- Turn the control box activation selector key (92) downwards to activate the ground control box.

2.2 - MAST MOVEMENT CONTROLS

Platform leveling is available, regardless of the work height. Even at low movement speeds, use the controls with caution.

N.B.:- Releasing the Enable Switch (228) will stop all movements.

Ground box controls (emergency station)

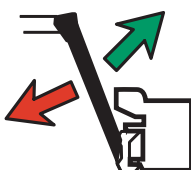
Control	Action
Mast Extend / Retract 	Push the mast selector switch (127) upwards to extend the mast.
	Push the mast selector switch (127) downwards to retract the mast.
Turret rotation 	Push the rotation selector switch (128) to the right to rotate the turret counterclockwise (CCW).
	Push the rotation selector switch (128) to the left to rotate the turret clockwise (CW).
Jib raising / lowering 	Push the jib switch (129) upwards to raise the jib.
	Push the jib switch (129) downwards to lower the jib.

2.3 - ADDITIONAL CONTROLS

For the machines equipped with flashing light :

- Press and hold the beacon button (105) to activate. Release beacon button (105) to turn OFF.

D - Operation instructions

3 - Platform control box

3.1 - TO START AND STOP THE MACHINE

To start the machine :

At the ground control box :

- The E-stop button on the ground control box must be in ON position (pulled out / activated).
- Turn the control box activation selector key (92) upwards to activate the platform control box.

At the platform :

- Pull the E-stop button (46).



To stop the machine (Only in the event of an emergency) :

- Push in the E-stop button (46).

3.2 - DRIVE AND STEER CONTROL

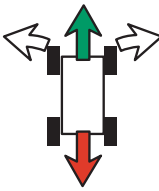

Before driving, locate the green / red orientation arrows on the chassis and platform control box. Move the drive controls in a direction matching the directional arrows.

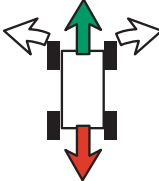
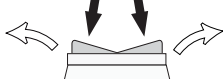
To operate driving and steering functions, select the desired movement (250) and simultaneously operate the drive joystick (244) and the joystick trigger (Enable switch).

Control	Action
	Press in button (250) to select either the drive or steer movement
Driving	 <p>Move the drive joystick (244) forwards with joystick trigger pressed in to drive the machine forwards.</p>
	 <p>Move the drive joystick (244) backwards with joystick trigger pressed in to drive the machine backwards.</p>
Steering	 <p>Push the button on top of joystick (244) to the left with joystick trigger pressed in, to steer left.</p>
	 <p>Push the button on top of joystick (244) to the right with joystick trigger pressed in, to steer right.</p>

D - Operation instructions

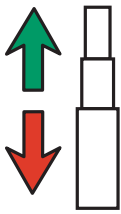
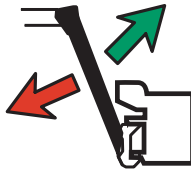
3.3 - MAST MOVEMENT CONTROLS

Control	Action
Mast Extend / Retract	Press button (251) to select Mast extend / retract movement 
	Push the joystick (244) forwards with joystick trigger pressed in to extend the mast. Push the joystick (244) backwards with joystick trigger pressed in to retract the mast.
Jib raising / lowering	Press button (252) to select Jib raising or lowering movement 
	Push the joystick (244) forwards with joystick trigger pressed in to raise the jib. Push the joystick (244) backwards with joystick trigger pressed in to lower the jib.
Turret rotation	Press and hold the button (132) and push the turret rotation selector switch (249) to the right for counterclockwise rotation (CCW). 
	Press and hold the button (132) and push the turret rotation selector switch (249) to the left for clockwise rotation (CW).

3.4 - ADDITIONAL CONTROLS

- Horn : Push the horn selector (43) to the right to sound the horn. The horn stops when the selector switch is released.

D - Operation instructions

4 - Emergency procedure

4.1 - IN CASE OF POWER LOSS

If an operating problem prevents the platform occupant from descending, a competent operator can perform the emergency procedures from the ground level.

In an emergency, if the operator has to exit the platform while it is elevated, the transfer of the operator must respect the following recommendations. :

- Exit onto a sturdy and safe structure.
- The occupant(s) must ensure that 2 lanyards are used for security/safety. One must be attached to the designated anchorage point on platform the occupant(s) is in and the other attached to the structure intended to get on.
- Occupant(s) must exit the current platform through the normal access.



The mast must be completely retracted before lowering the jib.

4.1.1 - Mast manual lowering procedure

- Pull the mast lowering solenoid knob located on the chassis right side to lower the mast.
- Release it to halt lowering.

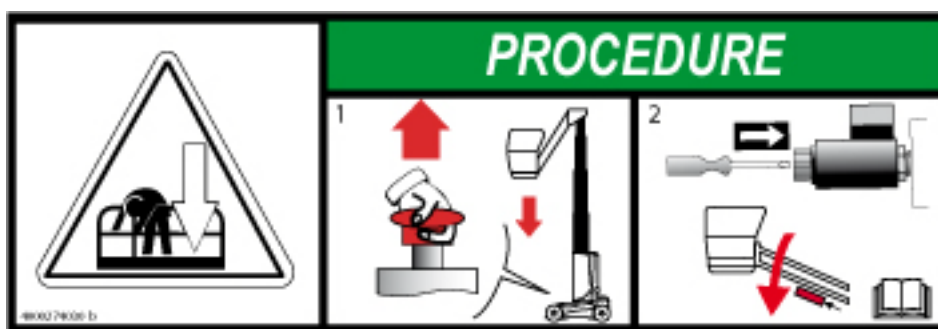

D - Operation instructions

4.1.2 - Jib manual lowering procedure

- Press the centre of the solenoid valve under the jib cylinder to lower the jib.
- Release it to halt lowering.

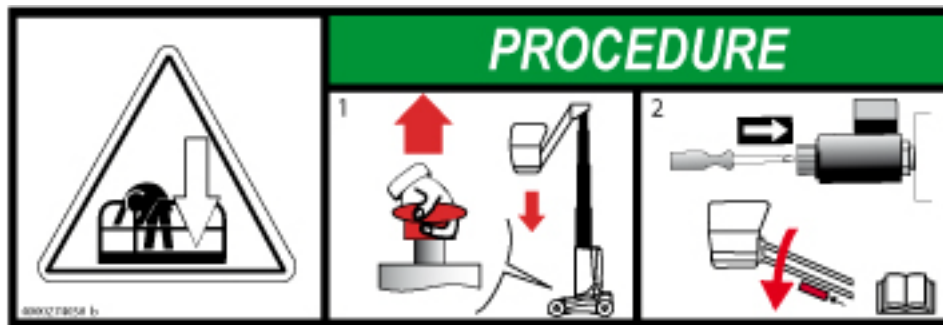

D - Operation instructions

4.2 - TO RESCUE OPERATOR IN PLATFORM

In a situation where an operator located in the platform needs to be rescued (for example in case of illness, injury or trapped against a structure making the control box inaccessible), the rescue personnel at ground level needs to obtain rapid and direct access to operating functions.

HAULOTTE® provides a ground control emergency system that should be used to safely bring the operator into such a position that appropriate medical attention could be provided.



The system allows occupant(s) to be lowered to the ground level, even if an E-Stop is engaged or if an overload is detected.

In this situation, the operator at the ground must :

- Turn the control box activation selector key (92) downwards to activate the ground control box.
- The platform box controls are now de-energized.
- Check that the E-Stop button (15) at ground is not pressed in.
- To lower the platform, hold down the enable switch (228) and simultaneously activate the desired control function.

N.B.: -If the platform E-stop button (15) or a safety device does not allow normal movement from the ground control box, use the overriding system. 



Operation of the "overriding system" switch must be an exception and not a normal emergency operation.

D - Operation instructions

Procedure :

- Turn the control box activation selector key (92) downwards to activate the ground control box.
- Push the "overriding" button (245) on the ACTIV'Screen.
- An activation confirmation appears on the screen.

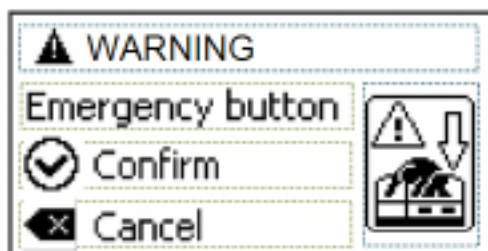

- Confirm "overriding" mode by activating button (255).
- The "overriding" mode is now activated.

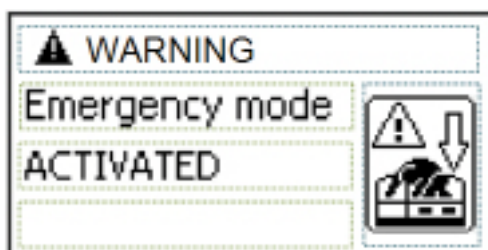

- Press and hold the "overriding" button (245).
- Simultaneously push the appropriate movement switch to bring the platform down to ground level.



Releasing the "overriding" (245) button for more than 8 s cancels the "overriding" mode.



Do not use the machine until all alarms are rectified.

"Overriding system" button

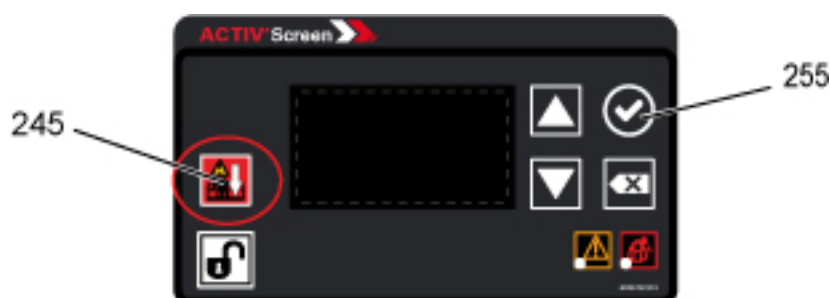

D - Operation instructions

4.3 - MANUAL EMERGENCY LOWERING PROCEDURE

This procedure is exclusively reserved for lowering in emergency situations only.

When the main energy source malfunctions, a hand pump located next to the hydraulic valve bank on the turntable, can be used to perform a manual descent.

Open the right hand compartment to access the pump and the valve bank.

This hand pump can be used in combination with a manual override multi electro-hydraulic valve bank, to perform mast lifting, turntable orientation and steering orientation (if the machine is towed)



This manual pump doesn't allow jib movements.



Lowering the platform with these methods increases the risk of overturning.



Follow the instructions on the decal near the distributor :

Do not attempt to perform this procedure using the multi electro-hydraulic valve bank without having already been trained by HAULOTTE Services®. All safety functions are inoperative and hazardous situations may occur. Improper use of equipment will result in death or serious injuries.

- Insert the lever (1) in the socket of the pump.

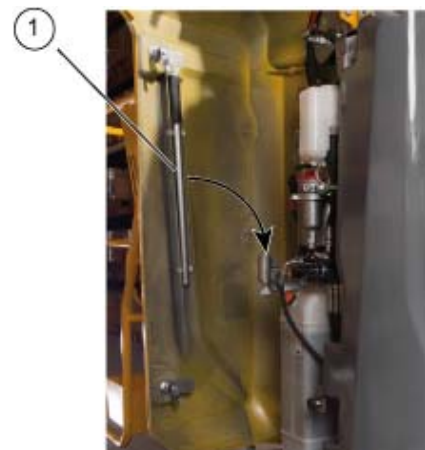

- Push the lever (1) from top to bottom several times while manually activating the selected function valve (2) simultaneously.

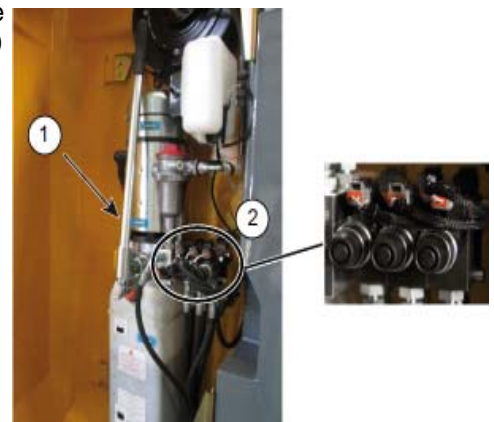

D - Operation instructions

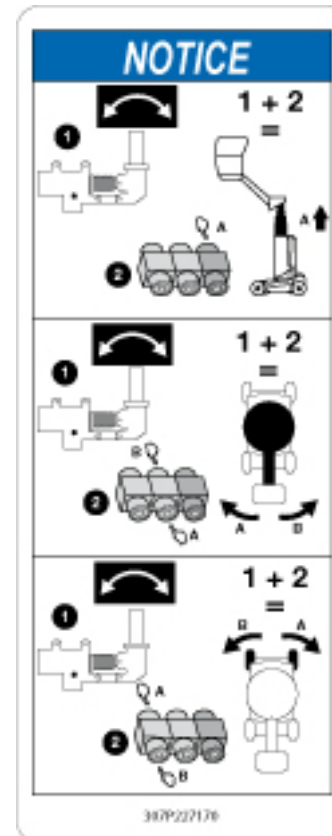

1 + 2 A : Mast lifting

1 + 2 A : Mast rotation (towards left)

1 + 2 B : Mast rotation (towards right)

1 + 2 A : Chassis rotation (to the right)

1 + 2 B : Chassis rotation (to the left)

If the operator cannot be lowered by any of the above mentioned methods, contact HAULOTTE Services® immediatly.

D - Operation instructions

5 - Transportation

5.1 - PUTTING IN TRANSPORT POSITION

During loading, ensure that :

- The loading ramp can support the machine weight.
- The loading ramp is correctly attached to transport vehicle.
- The loading ramp has sufficient grip surface.
- The transport vehicle must be parked on a level surface and must be secured to prevent rolling away while machine is being loaded or unloaded.

To climb the slope, select low driving speed.

If the slope is too steep, use a winch in addition to the low speed drive.

Do not place yourself below or too close to the machine during loading.



A wrong move can lead to machine tipping over and may cause serious injuries and material damage.

The machine must be completely in the stowed configuration :

- Check the platform is completely empty.
- Drive the machine onto the truck bed.
- Secure the machine to the tie down points provided (See picture).
- The covers must be locked.

5.2 - MACHINE LAYOUT

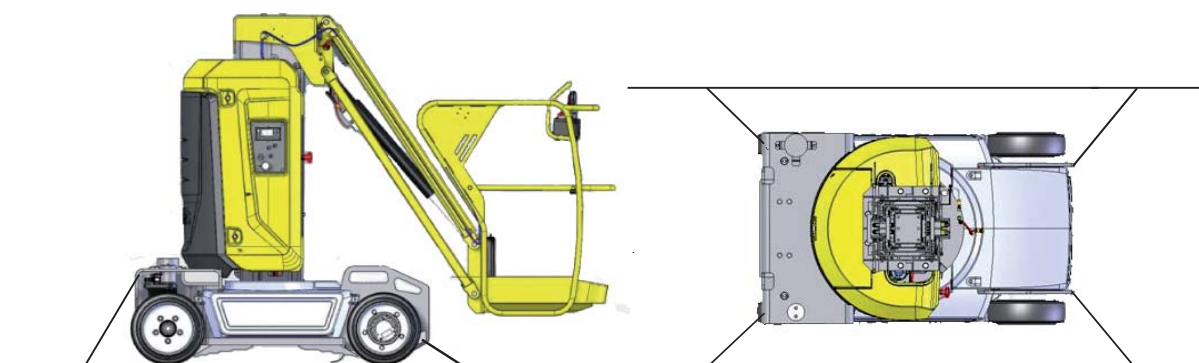

D - Operation instructions

5.3 - UNLOADING

Before unloading, check that the machine is in good condition.

- Remove the tie downs.
- Switch the machine on.
- Move progressively the drive joystick (244).



Warning : Upon starting a machine that has been secured and transported, the safety system may detect a false overload preventing all movement from the platform control box.

To reinstate the system, lift the jib a few centimetres (inches) using the ground control box.

5.4 - TOWING



In the event of a machine breakdown, the machine can be towed a short distance to load it onto a transport vehicle :

- **Ensure that no one is in the platform during towing.**
- **Ensure mast is fully retracted, jib is lowered to a stowed position, prior to towing.**
- **The platform must be empty.**
- **ALWAYS keep personnel and obstructions clear of the aerial work platform when brakes are released.**

To tow a broken-down machine, release brake (Refer to  Section D 5.4.1 Brake release). Perform this operation on flat ground with wheels chocked.

In the towing configuration, the machine braking system is inactive. Use of a drawbar is recommended :

- Do not exceed the maximum freewheel speed (Refer to  Section B 4 Technical specifications).
- Do not exceed a grade of 25%.

D - Operation instructions

5.4.1 - Electric brake release

To tow a broken-down machine, release brake.



Perform these operations on flat, horizontal ground. Failing that, block the wheels to immobilize the machine. During brake release operation, the machine is in free wheel mode and the brake system no longer functions.

In the event of machine traction, the drive wheels brake release is available via the switch located on the lower end of turret. It is accessible by opening the left hand compartment.

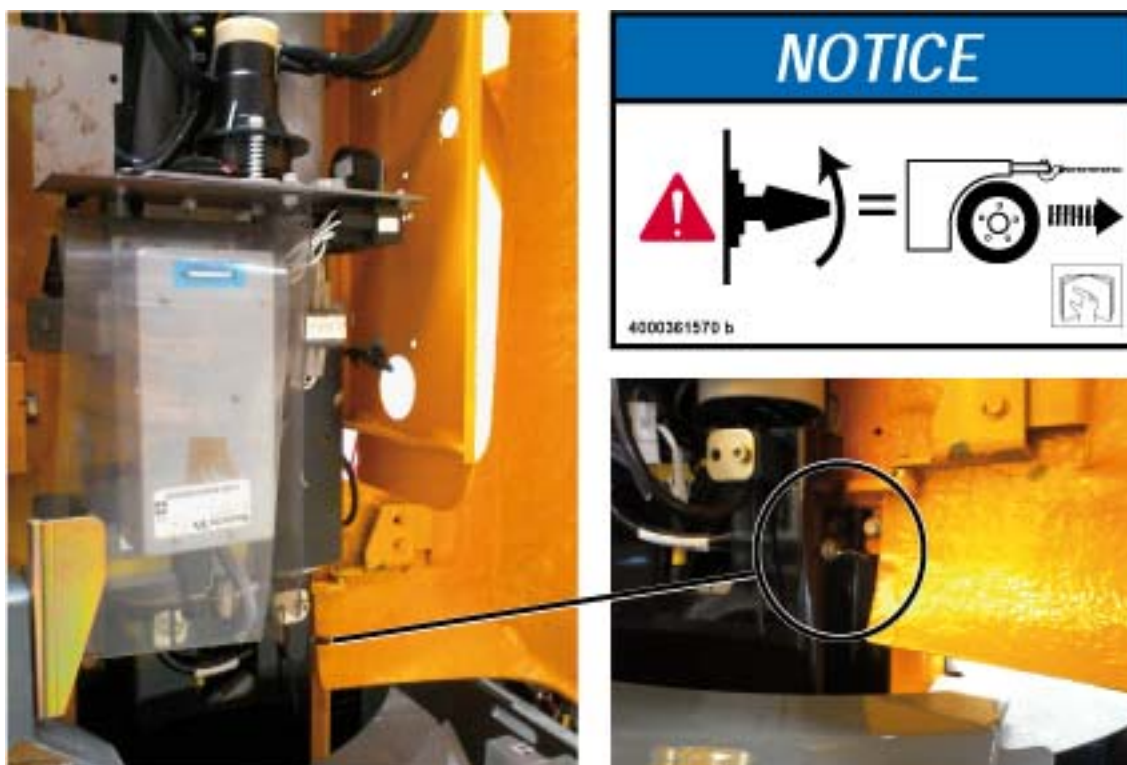

To release the machine's brakes, the following conditions must be met :

- The platform control box or the ground control box must be selected.
- The machine must be completely stowed.
- No movement selected.
- The machine must not be tilted.

Push the brake release button located on the inside bottom of the compartment for at least 3 s. An audible signal (beep) sounds.

Releasing the button disengages the brakes.

The brake release procedure stops automatically if the brake release button is pushed again, any actions are taken at the control boxes, the machine is turned off, or the control box in use is changed.

D - Operation instructions

5.5 - STORAGE



The machine can be stored in a designated area when not in use. If it has been stored for longer than 3 months without use then a periodic inspection must be conducted.

Machine must be parked in a protected/designated area with the mast fully retracted. Make sure there is no load in the platform.

It is recommended that the machine is not stored or immobilized unfolded.

Ensure all access panels, doors and side compartment covers are shut and secured.

Turn the energizing key selector switch (92) at the ground control box to the "center" position to shut OFF the power.

Shut off power to prevent unauthorized operation of the machine. Remove the ignition key to prevent unauthorized operation of the machine.



Storing of the machine with an obstacle under the platform structure is forbidden.



To avoid any risk of corrosion on rods of cylinders during a storage period of for more than 1 month :

- **In a normal atmospheric environment : perform a complete cycle for the cylinders every 2 months while they are in storage.**
- **In harsh environments (high levels of salinity in the atmosphere: close to the sea, industrial environment with chloride emissions and/or humidity >70%), we recommend applying the following protection process :**
 - Wash and rinse the entire machine with plenty of clean water.
 - Dry all the cylinder rods using an air gun.
 - Apply a solvent-based oil leaving an oily film after evaporation of the solvent directly to all rods left exposed when the machine is in storage position.
 - Re-apply the product every month.



After washing the machine, make sure it is fully air-dry and does not contain moisture on corrosive parts (cylinders rods for example).

D - Operation instructions

5.6 - LOADING BY RAMP



To avoid any risk of sliding during loading, ensure that :

- The loading ramp can bear the load.
- The loading ramp is correctly attached.
- The loading ramp has sufficient grip.



If the slope exceeds 25% grade, use a winch to assist in loading on to the ramp.



Never place yourself below or too close to the machine during loading.

A wrong move can lead to the tipping over of the machine and cause serious bodily and material accidents.

5.7 - UNLOADING BY RAMP



Before operating, check that the machine is in good condition.

If the machine has been damaged during transportation, contact the transporter in writing.

1. Remove the tie downs.
2. Start the machine.
3. Ensure the ramp is in good condition and of sufficient capacity. Ensure the lifting equipment ie. slings, shackles, hooks, lifting beam etc. are in good condition and of sufficient capacity.

5.8 - LIFTING OPERATION

5.8.1 - Loading and unloading

Before any lifting operation, it is necessary to take into account the following points :



ONLY trained and authorized personnel should attempt to lift the machine.

Do not operate machine unless you have :

- been fully trained and are qualified in proper operation.
- read and understood the information in the Operator's manual of the machine.

D - Operation instructions

5.8.1.1 - Safety precautions

It is the responsibility of the Operator to ensure there are no personnel or obstructions to safely perform the operation.

5.8.1.2 - Necessary equipment



- PPE (Personal Protective Equipment: glove, safety shoes, glasses, etc ...)
- Standard tool kit
- 2 spreaders 2 m (6 ft 7 in) 6 T
- 4 shackles 3 T
- 4 slings 2 m (6 ft 7 in) 3 T

Technical specifications

Machine type	Maximum weight
STAR 8	2600 kg (5733 lb)
STAR 10	2680 kg (5909 lb)
STAR 20J	2835 kg (6251 lb)
STAR 26J	2900 kg (6395 lb)

5.8.1.3 - Preliminary procedures

- Inspect the surrounding area and position the machine at a safe distance from electrically charged conductors to ensure that no part of the machine is within an unsafe area. Always stay clear of overhead obstructions.
- Respect the local rules and the minimum safe distance from power lines.
- Stop the machine.
- Remove the ignition key.
- Ensure that the main power is disconnected.
- Place a "DO NOT USE" decal near the start/stop switches to inform personnel that machine is not operational during the lifting process.
- Cordon off the area surrounding the machine to keep personnel, vehicles and moving equipment away from the machine.
- Remove all loose items from the machine.
- Ensure that vehicle capacity and loading equipment - hoists, slings, straps, etc. are of sufficient strength to withstand maximum machine weight.
- Attach the rigging ONLY to the designated lifting points on the machine.

D - Operation instructions

5.8.1.4 - Procedure for the use of slings

The machine must be completely stowed. Turntable line up with the chassis. Designated lifting points are marked/labeled with the following symbol .

1. Position the spreaders line up with the chassis.
2. Fold up the 4 slings 2 m (6 ft 7 in) 3 T over the tie-down points. Adjust properly to prevent any damage to the machine.



Pay particular attention to avoid slings over sharp edged surfaces as they may be severed/damaged.

3. Attach the slings using shackles



Properly adjust rigging to keep the machine level and to minimize the risk of damage to the machine.



- Lifting procedure must be handled very carefully.
- All movements of the machine must be performed slowly and deliberately to minimize swaying of the machine being lifted.
- Always keep machine as close as possible to the ground level.

5.8.2 - Lifting operation with tie-down points on the mast

Before any lifting operation, it is necessary to take into account the following points :



ONLY trained and authorized personnel should attempt to lift the machine.

Do not operate machine unless you have :

- been fully trained and are qualified in proper operation.
- read and understood the information in the Operator's manual of the machine.

D - Operation instructions

5.8.2.1 - Safety precautions

It is the responsibility of the Operator to ensure there are no personnel or obstructions to safely perform the operation.

5.8.2.2 - Necessary equipment



- PPE (Personal Protective Equipment: glove, safety shoes, glasses, etc ...)
- Standard tool kit
- 2 slings 3 m (9 ft 10 in) 6 T

Technical specifications

Machine type	Maximum weight
STAR 8	2600 kg (5733 lb)
STAR 10	2680 kg (5909 lb)
STAR 20J	2835 kg (6251 lb)
STAR 26J	2900 kg (6395 lb)

5.8.2.3 - Preliminary procedures

- Inspect the surrounding area and position the machine at a safe distance from electrically charged conductors to ensure that no part of the machine is within an unsafe area. Always stay clear of overhead obstructions.
- Respect the local rules and the minimum safe distance from power lines.
- Stop the machine.
- Remove the ignition key.
- Ensure that the main power is disconnected.
- Place a "DO NOT USE" decal near the start/stop switches to inform personnel that machine is not operational during the lifting process.
- Cordon off the area surrounding the machine to keep personnel, vehicles and moving equipment away from the machine.
- Remove all loose items from the machine.
- Ensure that vehicle capacity and loading equipment - hoists, slings, straps, etc. are of sufficient strength to withstand maximum machine weight.
- Attach the rigging ONLY to the designated lifting points on the machine.

D - Operation instructions

5.8.2.4 - Procedure for the use of slings

The machine must be completely stowed. Turntable line up with the chassis. Designated lifting points are marked/labeled with the following symbol .

1. Position the spreaders line up with the chassis.
2. Fold up the 2 slings 3 m (9 ft 10 in) 6 T over the tie-down points. Adjust properly to prevent any damage to the machine.



Pay particular attention to avoid slings over sharp edged surfaces as they may be severed/damaged.

3. Attach the slings using shackles



Properly adjust rigging to keep the machine level and to minimize the risk of damage to the machine.



- Lifting procedure must be handled very carefully.
- All movements of the machine must be performed slowly and deliberately to minimize swaying of the machine being lifted.
- Always keep machine as close as possible to the ground level.

D - Operation instructions

5.9 - LOADING AND UNLOADING WITH FORKLIFT

- Lower the mast and jib.



The machine must be in the fully stowed transport position.

- Ensure that the machine controls are in the OFF position.
- Forklift used to load and unload must have adequate capacity (Refer to  Section B 4 Technical specifications).
- Adjust the forklift forks spread to match with the machine fork pockets.
- Carefully insert the forklift forks in the designated machine fork pockets.



Never place yourself below or too close to the machine during loading.

A wrong move can lead to machine tipping over and may cause serious injuries and material damage.
Unloading

- Carefully lift the machine and make sure that the machine weight is properly balanced.
- Slowly lower the machine and place it on the ground.

D - Operation instructions

6 - Hydraulic oil

External environmental conditions can reduce performance of the machine if the hydraulic oil temperature does not reach its optimum range.

It is recommended to use the hydraulic oil according to weather condition. Refer to the table below.

Environmental conditions	SAE Viscosity grade
Ambient temperature between - 15°C (5°F) and + 40°C (+ 104°F)	HV 46
Ambient temperature between - 35°C (- 31°F) and + 35°C (+ 95°F)	HV 32
Ambient temperature between 0°C (+ 32°F) and + 45°C (+ 113°F)	HV 68

N.B.: -It is recommended to replace low temperature oil as the ambient temperature reaches + 15°C (59°F). It is not advisable to mix oils of different brands or types.

D - Operation instructions

7 - Battery care and maintenance

7.1 - CENTRALIZED BATTERY REFILLING

In cold weather conditions, centralized battery filling does not function.
Perform battery filling manually.

N.B.-:Levelling of the elements should always be done after charging the batteries.

Refer to the Maintenance manual.

7.2 - BATTERY CHARGING

Recharge aerial work platform batteries after each 8 hour work shift or as needed. When the aerial work platform is not in use, batteries should be recharged at least once per week. Under normal circumstances, battery recharge should take approximately 8-10 hours. However, a full recharge may take up to 24 hours, if the battery charge is extremely low.

Battery charger status

Ground control box :

The indicator (90) indicates charge status.

- Green indicator : Battery charged 100 %.
- Yellow LED : Battery charged 80 %.
- Red LED : Battery in initial charging phase.

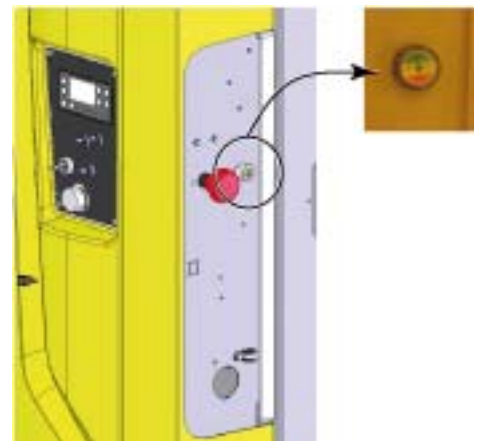

Platform control box :

The indicator (135) indicates charge status.

- Battery charged :
- Flashing : Batteries have 40% charge left :
- Constantly on : Batteries have only 20% charge left :

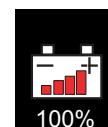

D - Operation instructions

When should the batteries be charged ? :

- Do not let the battery discharge to below 20 %.
- When the batteries are discharged to between 35 % and 80 % of their nominal capacity.
- If installing new batteries, recharge them after 3 or 4 hours of use 3 to 5 times.
- After a long period of non-use.
- Never leave the batteries discharged.
- Do not put off recharging the batteries in cold weather as the electrolyte may freeze.



- **Do not recharge the batteries if the temperature of the electrolyte exceeds 40 °C(104 °F) . Allow to cool down.**
- **Keep the top of the batteries clean and dry. Incorrect connection or corrosion may cause a high loss of power.**
- **The charger settings are adjusted in the factory using its own cable. If the cable needs changing, the HAULOTTE® factory must be contacted to obtain authorisation.**

How to charge the batteries ? :



Before charging the batteries, switch the machine off.

- Use the machine's on-board charger. The charger has a charge rate compatible to the battery capacity.
- Ensure that the mains supply is compatible to the charger's consumption.
- Top up the batteries with distilled water to the minimum electrolyte level if any of the elements are below this minimum level.
- Work in a clean and well-ventilated area away from naked flames.
- Move the aerial work platform to a well-ventilated area with direct access to a AC electrical outlet.

Charger type	24 V - 35 Ah
Electric power supply	220 V single phase 50 Hz 120 V single phase 60 Hz 80 V single phase 50 - 60 Hz
System voltage	24 V
Charging time	Approximately 10 h for batteries discharged to 80 %

A

B

C

D

E

F

G

H

I

D - Operation instructions

How to maintain battery autonomy ? :

- Do not charge the batteries in cold temperatures.
- The battery life is reduced when the machine is used in cold temperatures ($< 0\text{ }^{\circ}\text{C}$ ($32\text{ }^{\circ}\text{F}$)).
- If the machine is not going to be used for a length of time, shut-off the power with battery isolation switch.
- Do not let the battery discharge to below 20 %.
- If batteries are deeply discharged ($<10\%$); standard battery charger may not be enough to recharge battery.

To recharge the aerial work platform batteries :

Attach a 12 AWG multi-strand, grounded extension cord with a maximum length of 15 m (50 ft) to the receptacle located on the charger.

Plug the extension cord into outlet.

Start-up is automatic as soon as the mains connection is established. The charger is fitted with a LED indicator placed near the special holding frame :

- Green indicator : Battery charged 100 %
- Yellow LED : Battery charged 80 %
- Red LED : Charger in the initial charge phase

The CHARGING indicator LED remains lit continuously during the first stage of the charge cycle. The charge current will be displayed on the BATTERY CHARGER FACEPLATE.

To display the Battery Voltage, press (push) in and hold the BATTERY VOLTAGE button.



Do not disconnect any output leads or connectors between the batteries and the charger when the charger is on. To stop a charge in progress, always unplug the extension cord from the AC power source.



Recharge batteries in a well-ventilated area only. Do not charge batteries near fire, spark or other potential ignition sources. Batteries may emit highly explosive hydrogen gas while charging. Failure to properly ventilate the charge gasses could result in death or serious injury. Always charge aerial work platform batteries away from flammable materials.



ALWAYS avoid contact with battery acid. Battery acid causes serious burns and should be kept away from skin or eyes. If contact occurs, flush with water and consult a physician immediately.

When the battery charge reaches 80% of capacity, the yellow 80% CHARGED indicator LED will become lit and the green CHARGING indicator LED will begin to flash.

Unplug the extension cord from the outlet and the charger receptacle on the aerial work platform. Store the extension cord for next use.

N.B.:-Always unplug the battery charger power cord before moving the aerial work platform. Failure to disconnect power cord could cause damage to the equipment.

E - General Specifications

1 - Machine dimensions

Stowed / Transport position : Configuration that takes the minimum floor space necessary for storage and / or delivery of the machine - Access position.

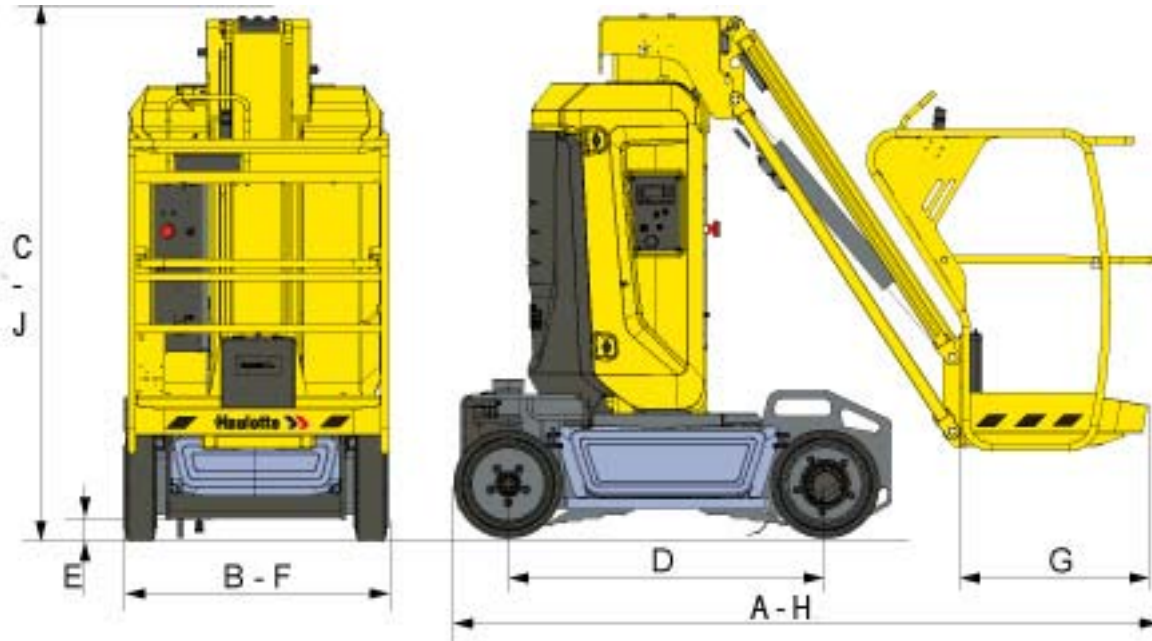

E - General Specifications

CE, AS and EAC standards

Machine		STAR 8		STAR 10	
Marking	Specifications - Dimensions	SI	Imp.	SI	Imp.
A	Overall length of machine	2,70 m	8 ft 10 in	2,70 m	8 ft 10 in
B	Overall width of machine	1,0 m	3 ft3 in	1,0 m	3 ft3 in
C	Overall height of machine	2,0 m	6 ft 7 in	2,0 m	6 ft 7 in
D	Wheel base	1,20 m	3 ft 11 in	1,20 m	3 ft 11 in
E	Ground clearance - Chassis	10 cm	4 in	10 cm	4 in
E	Ground clearance - Potholes	3,3 cm	2 in	3,3 cm	2 in
F X G	Platform dimensions	0,98 x 0,78 m	38 in x 30 in	0,98 x 0,78 m	38 in x 30 in
H	Storage length	2,70 m	8 ft 10 in	2,70 m	8 ft 10 in
J	Storage height	2,00 m	6 ft 7 in	2,00 m	6 ft 7 in

ANSI and CSA standards

Machine		STAR 22J		STAR 26J	
Marking	Specifications - Dimensions	SI	Imp.	SI	Imp.
A	Overall length of machine	2,70 m	8 ft 10 in	2,70 m	8 ft 10 in
B	Overall width of machine	1,0 m	3 ft3 in	1,0 m	3 ft3 in
C	Overall height of machine	2,0 m	6 ft 7 in	2,0 m	6 ft 7 in
D	Wheel base	1,20 m	3 ft 11 in	1,20 m	3 ft 11 in
E	Ground clearance - Chassis	10 cm	4 in	10 cm	4 in
E	Ground clearance - Potholes	3,3 cm	2 in	3,3 cm	2 in
F X G	Platform dimensions	0,98 x 0,78 m	38 in x 30 in	0,98 x 0,78 m	38 in x 30 in
H	Storage length	2,70 m	8 ft 10 in	2,70 m	8 ft 10 in
J	Storage height	2,00 m	6 ft 7 in	2,00 m	6 ft 7 in



E - General Specifications

2 - Major component masses

N.B.:-Masses measured with empty tanks.

Component	STAR 8	STAR 22J	STAR 10	STAR 26J
Frame assembly mass	645 kg - 1420 lb		685 kg - 1510 lb	
Drive wheel mass	18,5 kg - 40 lb			
Steer wheel mass	20,6 kg - 45 lb			
Turret assembly mass	542 kg - 1195 lb			
• Counterweight mass - Turret	834 kg - 1840 lb	1104 kg - 2435 lb	834 kg - 1840 lb	1104 kg - 2435 lb
• Battery mass	209 kg - 460 lb			
Jib assembly mass	150 kg - 330 lb		206 kg - 455 lb	
Platform assembly mass	65 kg -145 lb			

3 - Acoustics and vibrations

The acoustics and vibrations specifications are based upon the following conditions :

- The airborne noise emissions at workstation are determined per European Directive 2006/42/CE.
- The guaranteed sound power level LWA (displayed on the product) is determined per European Directive 2000/14/CE.
- The vibrations transmitted by the machinery to the hand/arm system and to the whole body are determined per European Directive 2006/42/CE.

Specifications	
Sound pressure level at workstation	72 dBA
Vibrations hand/arm	Vibration transmitted by this MEWP to the hand-arm does not exceed 2,5 m/s ² (98,4 in/s ²)
Vibrations whole body	Vibration transmitted by this MEWP to the whole body does not exceed 0,5 m/s ² (19,6 in/s ²)

E - General Specifications

4 - Wheel/Tire assembly

4.1 - TECHNICAL SPECIFICATIONS

Component	Standard wheel
Reference number	Solideal
Type	Solid tires/tyres
Drive wheel mass	18,5 kg - 40 lb
Steer wheel mass	20,6 kg - 45 lb
Size	406 mm / 100 mm (16 in/ 4 in)
Torque	115 Nm (84.81 ft lbs)

4.2 - INSPECTION AND MAINTENANCE

Replace the wheels and the tires if any of the following conditions exist :

- Presence of cracks, damage, deformation or other faults on the hub
- Damage to the tire :
 - Cut or hole > 3 cm (2 in) in the rubber side wall.
 - Blister or pronounced lump on the external and lateral wall.
 - Damaged wheel stud.
 - Damage or wear on the side wall to the extent that the reinforcing wire is visible.
- Consistent wear of the ground contact surface greater than 25%

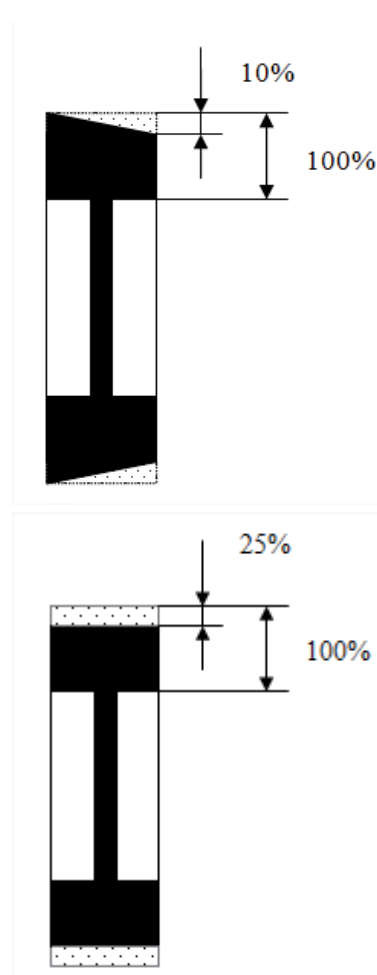

Tires and rims are critical components for the stability of the machine. For safety reasons :

- Use only HAULOTTE® spare parts according to the technical characteristics of the machine. Refer to the spare parts catalog.
- Do not replace factory-installed tires with tires of different specifications or ply rating.
- Never replace solid tire with a pneumatic (air filled) tire.

E - General Specifications

Procedure of replacement :

- Loosen the wheel nuts on the wheel to be removed.
- Raise the machine using a jack or a hoist.
- Remove the wheel nuts.
- Remove the wheel.
- Install the new wheel.
- Lower the machine to the ground.
- Tighten the wheel nuts to the recommended torque.

N.B.:-If a wheel has been replaced, while observing the axle track pattern check for correct installation.

E - General Specifications

5 - Options

5.1 - ACTIV' SHIELD BAR - SECONDARY GUARDING SYSTEM (IF FITTED)

5.1.1 - Description



General Specification Activ' Shield Bar :

- The Activ' Shield Bar is a device designed to reduce the risk of entrapment against the control panel when the platform is in confined spaces.
- This device is complementary to the existing operator protection including the enable switch system (Trigger of joystick, 'Enable switch' foot pedal and 'Enable switch' on ground control box).
- The Activ' Shield Bar is active when the platform is elevated (boom or arm) and creep speed is automatically engaged. It is not enabled when stationary or in the transport position, when drive, turret rotation and jib raise are possible.
- The green indicator light of the Activ' Shield Bar is illuminated indicating the device is active.



This system does not relieve the operator from the responsibilities of learning and practicing the principles of safe use and operation of the machine as provided by the manufacturer's instructions, employer's safety rules and worksite regulations

A

B

C

D

E

F

G

H

I

E - General Specifications

5.1.2 - Characteristics

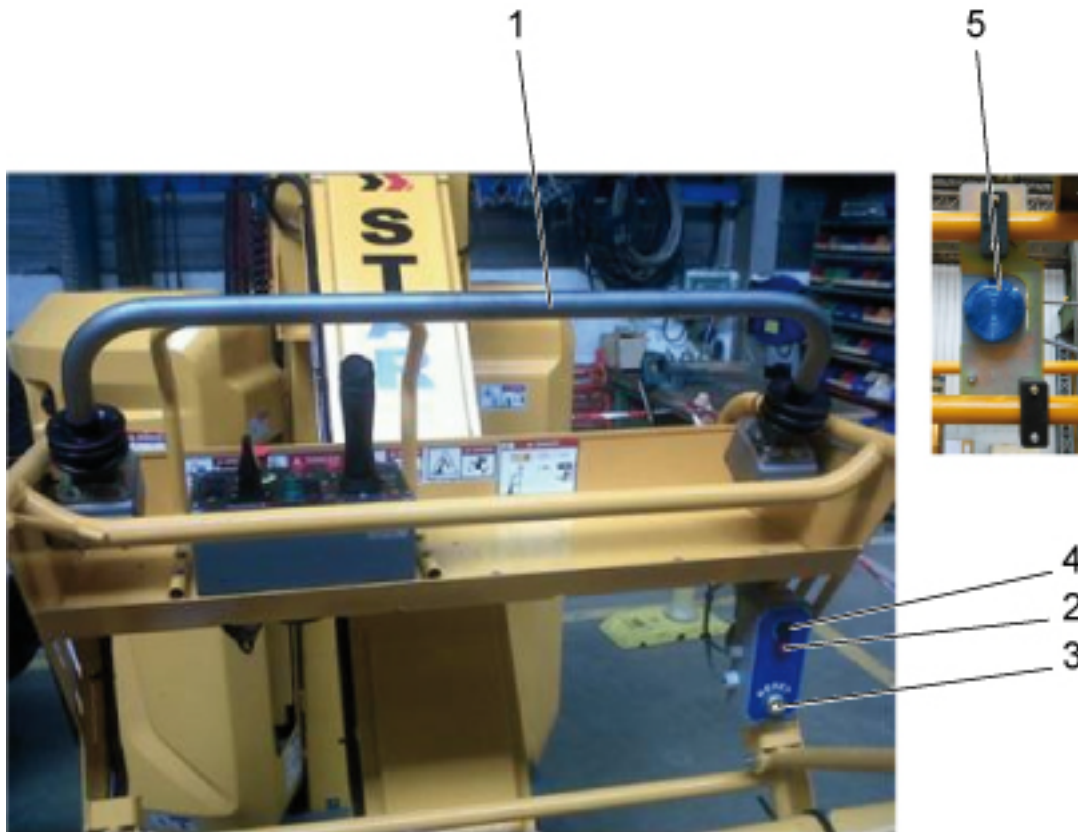

Marking	Description
1	Activation bar
2	Electrical box
3	"RESET" button
4	Green indicator light
5	Blue flashing indicator, indicates activation bar operates

E - General Specifications

5.1.3 - Safety precautions



It is mandatory to ensure that the **Activ' Shield Bar** is functional at each start-up of the machine



Do not use the **Activ' Shield Bar** as a handhold. This could result in an inadvertent triggering of the **Activ' Shield Bar**.

- Check the work area for overhead clearances, obstructions or other possible hazards.
- When driving, position the platform so as to provide the best visibility possible and avoid any blind spots.
- Always ensure that the chassis is never driven any closer than 1 m (3 ft3 in) from holes, bumps, tilts, obstructions, debris and ground coverings that may hide dangers.
- During operation, keep all the parts of the body inside the platform.
- To position the machine close to obstacles, it is recommended to use boom movements (arm, boom, etc.) instead of the drive movements.
- Do not drive fast in narrow or cluttered areas. Keep speed under control while making turns or sharp bends.
- Do not use the **Activ' Shield Bar** as a handhold. To prevent unintentional activation of the system.

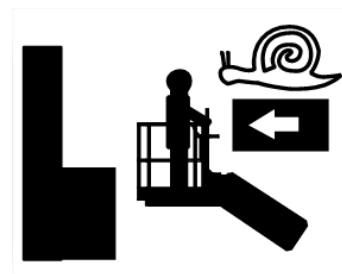
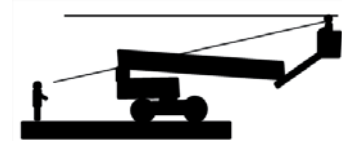

E - General Specifications

5.1.4 - Pre-operation inspection



- If any item on the checklist is marked NO during the inspection; machine must be tagged and locked out and placed out of service.
- DO NOT operate the machine until all identified items are corrected and it has been declared safe for operation.

Description	Yes	No
Perform all specified machine functional tests		
• All machine functional tests result positive		
Start the machine from platform control box		
Switch off (pushed in) all E-Stop buttons		
• Check absence of warning signal		
• Check that the light indicator is not activated when the machine is in stowed position		
To ensure Activ' Shield Bar device is functioning correctly, perform the following :		
When stowed : • Check that the green indicator light is not illuminated		
Raise the extendible structure (mast, jib) out of transport configuration : • Check that the green indicator light is illuminated		
Simultaneously make a movement and push forward the activation bar to trigger the system : • Check that all movements stop • Check that the horn and the blue flashing light are activated		

5.1.5 - Operation

If the Activ' Shield Bar is pushed forward, all movements are stopped. The horn sounds and the warning blue light flashes. Only movements to move away from the entrapment are authorised.

To re-set the Activ' Shield Bar, release the activation bar, the 'Enable switch' and controls. Then press the reset button.

Care must be taken during all operations to prevent collision and entrapment against structures.

E - General Specifications

5.1.6 - Specific decals

Location of the decals

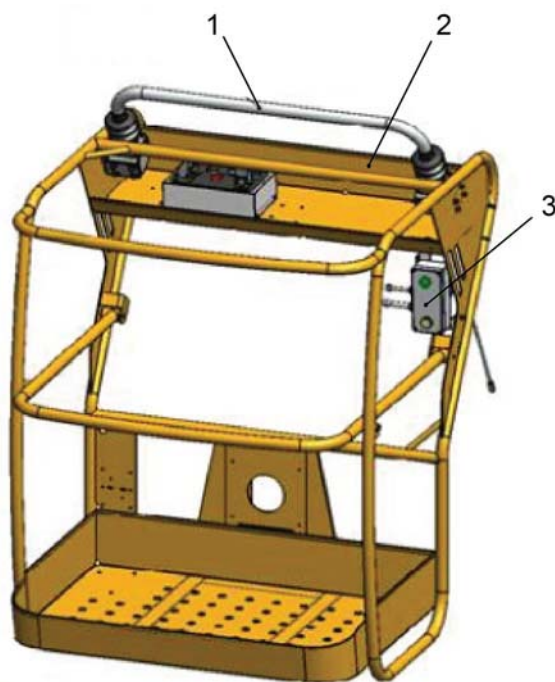

Marking	Description	Quantity	Part number
1	Electrical box	1	4000614500
2	Activ' Shield Bar instructions	1	4000612200
3	Activ' Shield Bar controls	1	4000206690

Activ' Shield Bar instructions

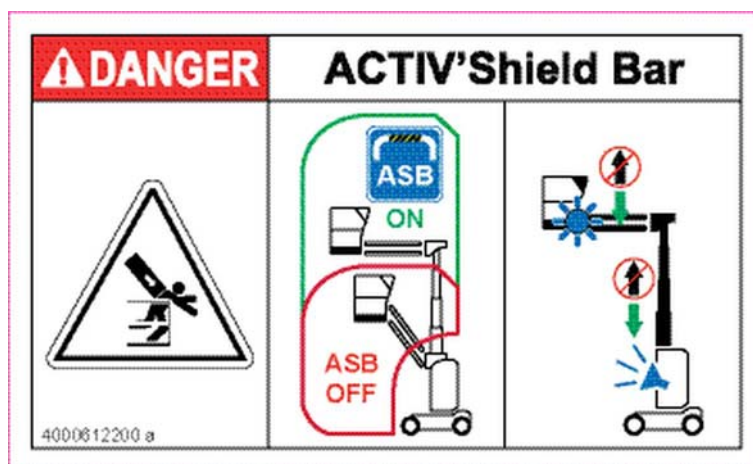

F - Maintenance

1 - General

As an owner and/or operator of Haulotte equipment, your Safety is of utmost importance to HAULOTTE®, which is why HAULOTTE® places such a high priority on product safety.

INSPECTIONS are not only required by HAULOTTE®, but may also be required by industry standards and/or governmental regulations.

To ensure that your equipment continues to perform to the factory set performance levels, it is important that you regularly maintain your equipment and avoid making any modifications that are not approved by HAULOTTE®. Regular and timely inspections will reduce equipment down time as well as prevent possible injury.

N.B.:-DO NOT OPERATE unless you are familiar and trained in the principles of safe machine operation.

Overview :

- Walk-around inspections take only a few minutes at the beginning and end of each shift – one of the best ways to prevent mechanical problems and safety hazards.

What to Do :

- Use your senses: sight, smell, hearing and touch.

Frequency :

- Check your machine periodically during your entire workday.
- Make sure to do your inspection the same way every time.
- Complete one of these inspections at the start and end of each shift.

N.B.:-If damage or unauthorized modifications are discovered, the machine must be removed from service until repairs are made by a qualified service technician.

It is the owner's responsibility to ensure the required maintenance as recommended by Haulotte is completed prior to the operation of the machine.

If regular maintenance is not carried out, this may :

- Void the warranty.
- Cause machine malfunction.
- Reduce machine reliability and shorten its service life.
- Jeopardize operator safety.

HAULOTTE Services® technicians are specially trained to carry out extensive repairs, interventions or adjustments on the safety systems or elements of HAULOTTE® machines. They carry genuine HAULOTTE spare parts and tools as required, and also provide fully documented reports on all work completed.

The inspection and maintenance table, identifies the role and the responsibilities of each party in periodical machine maintenance.  Section C 3 Inspection and Functional test.

F

- Maintenance

2 - Maintenance Schedule

This section provides the necessary information needed to place the machine in safe operation. According to the current regulations, this machine has been designed for a minimum service life of 10 years. The life may be extended or reduced dependent on the severity of operating conditions, the machine condition itself and by conducting effective inspections and maintenance in addition to other external factors. There are a number of factors which can affect the design life including but not limited to, severity of operating conditions/routine maintenance which should be carried out in accordance with this manual.

Severity of operating conditions may require a reduction in time between maintenance periods. Machines that have been out of service or have not been in use for more than 3 months must undergo a periodic inspection before the machine is put back into service.

Maintenance must be carried out by a competent company or person familiar with mechanical procedures.

Maintenance operations performed must be recorded in a register / log book of the machine.

F - Maintenance

3 - Inspection program

3.1 - GENERAL PROGRAM

The machine must be inspected on a regular basis at intervals of no less than once 1 per year. The purpose of the inspection is to detect any defect which could lead to an accident during routine use of the machine. Local standards and regulations may require more frequent inspections.

HAULOTTE® requires Reinforced and Major Inspections to be carried out on the product to extend its service life.

Inspections must be carried out by a competent company or person.

The inspection results must be recorded in the safety register or machine log book controlled and overseen by the company manager. This register or machine log book and the list of competent repair persons must be made available to the government work inspector and HAULOTTE Services®.

When	Responsible	Stakeholder	What
Before sale	Owner (or renter)	Competent technician or qualified technician HAULOTTE Services®	Periodic inspection
Before rent	Owner (or renter)	Competent technician or qualified technician HAULOTTE Services®	Daily inspection
Before use or every change of user	User	User	
Annually (1 year)	Owner (or renter)	Competent technician or qualified technician HAULOTTE Services®	Periodic inspection
5 years	Owner (or renter)	Qualified technician HAULOTTE Services®	Reinforced inspection
10 years	Owner (or renter)	Qualified technician HAULOTTE Services®	Major inspection

F

- Maintenance

3.2 - DAILY INSPECTION

The Daily inspection includes a visual inspection, operational checks and testing of the safety systems. This must be conducted by the operator before using the machine.

This inspection is the responsibility of the user. Refer to  Section C 3.1 Daily inspection.

3.3 - PERIODIC INSPECTION

The Periodic inspection is a thorough evaluation of the operation and safety features of the machine.

It must be conducted before the sale / resale of the machine and/or at least 1 every year.

Local regulations may have specific requirements on frequency, and content of inspections.

The severity of operating conditions may require frequent inspections.

This inspection is the responsibility of the owner, and inspections must be carried out by a competent company or person.

This inspection is in addition to the daily inspection.

This inspection should also be conducted after :

- Extensive dismantling and reassembly of major components.
- Repairs involving the machine's essential components.
- Any accident causing stress to the machine.

3.4 - REINFORCED INSPECTION

The Reinforced inspection is a thorough evaluation of the machine's structural components, to ensure proper functionality of the machine.

This evaluation must occur at a frequency of 5000 hours or every 5 years.

This inspection is the responsibility of the owner, and it must be conducted by a HAULOTTE Services® technician or by a competent company or person.

This inspection includes :

- Daily inspection
- Periodic inspection

N.B.:- Refer to the Maintenance manual for details.

F

- Maintenance

3.5 - MAJOR INSPECTION

The Major inspection is a thorough evaluation of the machine's integrity and proper functioning; after a normal service life of 10 years.

This evaluation must take place after 10 years of operation and then repeated every 5 years thereafter.

The severity of operating conditions may require frequent inspections.

This inspection is the responsibility of the owner, and it must be conducted by a HAULOTTE Services® technician.

This inspection includes :

- Daily inspection
- Periodic inspection
- Reinforced inspection

***N.B.**:-Refer to the Maintenance manual for details.*

A

B

C

D

E

F

G

H

I

F

- Maintenance

4 - Repairs and adjustments

Extensive repairs, interventions or adjustments on the safety systems or components must be performed by a HAULOTTE Services® technician. Use original spare parts and components only.

***N.B.**:-HAULOTTE Services® technicians are trained professionals to perform extensive repairs, interventions and adjustments on the safety systems or components of HAULOTTE® machines. The technician carries genuine HAULOTTE® spare parts and tools as required, and also provides fully documented reports on all work completed.*

HAULOTTE Services® will not take responsibility for any outcomes resulting from inferior services or repairs performed by other unauthorised personnel.

HAULOTTE® reminds that NO modifications SHALL be carried out without the written permission of HAULOTTE®.

Any unauthorised repairs/modifications will void HAULOTTE® warranty.

With the utmost care to ensure enhanced reliability and greater safety of the HAULOTTE® products, it is pertinent that when a "Service or Safety Bulletin" is issued, action is taken immediately. Once the bulletin has been addressed, make sure that the completed form is submitted to HAULOTTE®.

***N.B.**:-When disposing or scrapping this machine, please consider appropriate methods of recycling. Any items that require specific disposal are listed with instructions in the maintenance manual.*

G - Other information

1 - Warranty disclosure

1.1 - AFTER SALES SERVICE

Our HAULOTTE Services® After Sales Service is at your disposal throughout your machine's service life to ensure the optimum use of your HAULOTTE product :

- When contacting our After Sales Service, ensure that you provide the machine model and serial number.
- When ordering any consumables or spare parts, please use this manual and the HAULOTTE® Essential catalogue to receive your genuine HAULOTTE® spare parts, your only guarantee of parts interchangeability and correct machine operation.
- If there is an equipment malfunction involving a HAULOTTE® product, then contact HAULOTTE Services® immediately even if the malfunction does not involve material and/or bodily damage.

1.2 - MANUFACTURER'S WARRANTY

1.2.1 - Warranty acceptance

On reception of his machine, the owner or rental company must check the machine's condition and fill out the machine reception slip provided.

1.2.2 - Warranty period

The present warranty is valid for a period of 12 months or up to a maximum of 1000 operating hours for lifting and handling equipment and 2000 operating hours for public works machinery, starting from delivery and terminating when the first limit is reached.

Spare parts are covered by a 6 month warranty.

1.2.3 - Procedure conditions

To benefit from the warranty, the owner or rental company must inform the nearest HAULOTTE® subsidiary or the subsidiary that delivered the machine (the only dealer authorised to carry out an intervention under the manufacturer's warranty agreement) of the defect in writing as quickly as possible.

The subsidiary will decide whether to repair or replace the part that proves to be faulty. ➤

The owner or rental company must present the duly completed maintenance book supplied with the machine as proof that the maintenance operations recommended by the manufacturer have been carried out.

The owner or rental company must ensure that the defect covered by the HAULOTTE® warranty is reported to and acknowledged by the HAULOTTE® subsidiary as rapidly as possible or must report the defect in writing.

Work carried out under the HAULOTTE® warranty will be performed by the subsidiary which delivered the machine, wherever possible.

G - Other information

1.2.4 - Conditions of warranty

HAULOTTE® guarantees its products against defects, faults or manufacturing defects when the owner or rental company has informed HAULOTTE® of the defect.

The warranty does not cover the consequences of normal wear, nor any defects, failure or damage resulting from poor maintenance or abnormal usage, in particular overloading, impact by an external source, faulty installation or any modification made to products marketed by HAULOTTE® and performed by the owner or rental company.

In the event of operation or use which does not comply with the instructions or recommendations in the maintenance book, warranty claims will not be accepted.

The machine utilisation period must be recorded by reading the engine hour meter whenever an intervention is made. The engine hour meter must be maintained in good working order to guarantee maximum working life and to justify maintenance at the recommended time.

Warranty obligations for the time period stated above will cease immediately in situations where the defect is due to the following reasons :

- Use of spare parts that are not HAULOTTE® originals.
- If elements or products other than those recommended by the manufacturer are used.
- If the HAULOTTE® name, serial numbers or identification marks are removed or altered.
- After an unreasonably long delay before reporting a manufacturing problem.
- If the owner or rental company continues to use the machine despite problems.
- If damage is caused by modifications that do not comply with HAULOTTE® specifications.
- If lubricants, hydraulic oils or fuels that do not comply with HAULOTTE® recommendations are used.
- If the machine is incorrectly repaired or used by the customer.
- In case of an accident caused by a third party.

If no particular agreement has been made, any claims made after the previously established warranty period has expired will be refused.

G - Other information

The present warranty does not cover damage that may result directly or indirectly from any flaws or defects covered by the latter :

- Consumables : No claims will be accepted for objects or parts replaced in the context of normal machine usage.
- Settings : Adjustments of all sorts may become necessary at any time. Therefore adjustments are considered a part of normal machine usage conditions and are not covered by the warranty.
- Hydraulic and fuel circuit contamination : Every possible precaution is taken to ensure that fuel and hydraulic liquid delivered is clean. HAULOTTE® will not accept any claims concerning cleaning of the fuel circuit, filter, injection pump or any other equipment in direct contact with fuel or lubricants.
- Wearing parts (pads, bearings, tires/tyres, connections, etc.) : These parts are, by definition, subject to deterioration during the period of operation. Wearing parts will therefore not be covered by the warranty agreement.

A

B

C

D

E

F

G

H

I

G - Other information

2 - Subsidiary contact information

	<p>HAULOTTE FRANCE PARC DES LUMIERES 601 RUE NICEPHORE NIEPCE 69800 SAINT-PRIEST TECHNICAL Department: +33 (0)820 200 089 SPARE PARTS : +33 (0)820 205 344 FAX : +33 (0)4 72 88 01 43 E-mail : haulottefrance@haulotte.com www.haulotte.fr</p>		<p>HAULOTTE ITALIA VIA LOMBARDIA 15 20098 SAN GIULIANO MILANESE (MI) TEL: +39 02 98 97 01 FAX: +39 02 9897 01 25 E-mail : haulotteitalia@haulotte.com www.haulotte.it</p>		<p>HAULOTTE INDIA Unit No. 1205, 12th floor, Bhumiraj Costarica, Plot No. 1&2, Sector 18, Palm Beach Road, Sanpada, Navi Mumbai- 400 705 Maharashtra, INDIA Tel. : +91 22 66739531 to 35 E-mail : sray@haulotte.com www.haulotte.in</p>
	<p>HAULOTTE HUBARBEITSBÜHNEN GmbH Ehrenkirchener Strasse 2 D-79427 ESCHBACH TEL : +49 (0) 7634 50 67 - 0 FAX : +49 (0) 7634 50 67 - 119 E-mail : haulotte@de.haulotte.com www.haulotte.de</p>		<p>HAULOTTE VOSTOK 61A, RYABINOVAYA STREET Bldg. 3 121471 MOSCOW RUSSIA TEL/FAX : +7 495 221 53 02 / 03 E-mail : info@haulottevostok.ru www.haulotte-international.com</p>		<p>HAULOTTE DO BRASIL AV. Tucunaré, 790 CEP: 06460-020 – TAMBORE BARUERI – SAO PAULO – BRASIL TEL : +55 11 4196 4300 FAX : +55 11 4196 4316 E-mail : haulotte@haulotte.com.br www.haulotte.com.br</p>
	<p>HAULOTTE IBERICA C/ARGENTINA Nº 13 - P.I. LA GARENA 28806 ALCALA DE HENARES MADRID TEL : +34 902 886 455 TEL SAT : +34 902 886 444 FAX : +34 911 341 844 E-mail : iberica@haulotte.com www.haulotte.es</p>		<p>HAULOTTE POLSKA Sp. z o.o. UL. GRANICZNA 22 05-090 RASZYŃ - JANKI TEL : +48 22 720 08 80 FAX : +48 22 720 35 06 E-mail : haulottepolska@haulotte.com www.haulotte.pl</p>		<p>HAULOTTE MÉXICO, Sa de Cv Calle 9 Este, Lote 18, Cívac, Jiutepec, Morelos CP 62500 Cuernavaca México TEL : +52 77 7321 7923 FAX : +52 77 7516 8234 E-mail : haulotte.mexico@haulotte.com www.haulotte-international.com</p>
	<p>HAULOTTE PORTUGAL ESTRADA NACIONAL NUM. 10 KM. 140 - LETRA K 2695 - 066 BOBADELA LRS TEL : +351 21 995 98 10 FAX : +351 21 995 98 19 E-mail : haulotteportugal@haulotte.com www.haulotte.es</p>		<p>HAULOTTE SINGAPORE Pte Ltd. No.26 CHANGI NORTH WAY, SINGAPORE 498812 Parts and service Hotline: +65 6546 6150 FAX : +65 6536 3969 E-mail: haulotteasia@haulotte.com www.haulotte.sg</p>		<p>HAULOTTE MIDDLE EAST FZE PO BOX 293881 Dubai Airport Free Zone DUBAÍ United Arab Emirates TEL : +971 (0)4 299 77 35 FAX : +971 (0) 4 299 60 28 E-mail : haulottemiddle-east@haulotte.com www.haulotte-international.com</p>
	<p>HAULOTTE SCANDINAVIA AB Taljegårdsgatan 12 431 53 Mölndal SWEDEN TEL : +46 31 744 32 90 FAX : +46 31 744 32 99 E-mail : info@se.haulotte.com sparers@se.haulotte.com www.haulotte.se</p>		<p>HAULOTTE TRADING (SHANGHAI) Co. Ltd. #7 WORKSHOP No 191 HUA JIN ROAD MIN HANG DISTRICT SHANGHAI 201108 CHINA TEL : +86 21 6442 6610 FAX : +86 21 6442 6619 E-mail : haulotreshanghai@haulotte.com www.haulotte.cn</p>		<p>HAULOTTE ARGENTINA Ruta Panamericana Km. 34,300 (Ramal A Escobar) 1615 Gran Bourg (Provincia de Buenos Aires) Argentina TEL.: +54 33 27 445991 FAX. +54 33 27 452191 E-mail : haulotteargentina@haulotte.com www.haulotte-international.com</p>
	<p>HAULOTTE UK Ltd STAFFORD PARK 6 TELFORD - SHROPSHIRE TF3 3AT TEL : +44 (0)1952 292753 FAX : +44 (0)1952 292758 E-mail : salesuk@haulotte.com www.haulotte.co.uk</p>		<p>HAULOTTE GROUP / BILJAX 125 TAYLOR PARKWAY ARCHBOLD, OH 43502 – USA TEL : +1 419 445 8915 FAX :+1 419 445 0367 Toll free : +1 800 537 0540 E-mail : sales@us.haulotte.com www.haulotte-usa.com</p>		<p>HAULOTTE NORTH AMERICA 3409 Chandler Creek Rd. VIRGINIA BEACH, VA 23453 – USA TEL : +1 757 689 2146 FAX :+1 757 689 2175 Toll free : +1 800 537 0540 E-mail : sales@us.haulotte.com www.haulotte-usa.com</p>
	<p>HAULOTTE NETHERLANDS BV Koopvaardijweg 26 4906 CV OOSTERHOUT - Nederland TEL : +31 (0) 162 670 707 FAX : +31 (0) 162 670 710 E-mail info@haulotte.nl</p>		<p>HAULOTTE AUSTRALIA PTY Ltd 46 GREENS ROAD DANDENONG – VIC – 3175 TEL : 1 300 207 683 FAX : +61 (0)3 9792 1011 E-mail : sales@haulotte.com.au</p>		<p>HAULOTTE CHILE El Arroyo 840 Lampa (9380000) Santiago (RM) TEL : + 562 2 3727630 E-mail : haulotte-chile@haulotte.com www.haulotte-chile.com</p>

G - Other information

2.1 - CALIFORNIA WARNING

For electric (battery operated) machines

CALIFORNIA

PROPOSITION 65 BATTERY WARNING

Battery posts, terminals and related accessories contain lead and lead compounds, chemicals known to the State of California to cause cancer and reproductive harm. Batteries also contain other chemicals known to the State of California to cause cancer.

WASH HANDS AFTER HANDLING.

A

B

C

D

E

F

G

H

I

